



rev 1.3

**Low Power, 5V/3.3V,  $\mu$ P Reset, Active LOW, Open-Drain Output**

**General Description**

The ASM1233D-L/1233D/1233M are voltage supervisors with low-power, 5/3.3V  $\mu$ P Reset, with an active LOW, open-drain output. Maximum supply current over temperature is 15 $\mu$ A for 3.3V devices and 20 $\mu$ A for 5V devices.

The ASM1233D-L/1233D/1233M generates an active LOW reset signal whenever the monitored supply is out of tolerance. A precision reference and comparator circuit monitors power supply ( $V_{CC}$ ) level. The tolerance are 5%,10% and 15%. When an out-of-tolerance condition is detected, an internal power-fail signal is generated which forces an active LOW reset signal. After  $V_{CC}$  returns to an in-tolerance condition, the reset signal remains active for 350ms to allow the power supply and system microprocessor to stabilize.

The ASM1233D-L/1233D/1233M is designed with an open-drain output stage and operates over the extended industrial temperature range. These devices are available in compact SOT-223, SO-8 and TO-92 packages.

Other low power products in this family include ASM1810/11/12/15/16/17.

**Key Features**

- Low Supply Current
  - 15 $\mu$ A maximum ( $\leq$ 3.6V), 20 $\mu$ A maximum (5.5V)
- Automatically restarts a microprocessor after power failure
- 350ms reset delay after  $V_{CC}$  returns to an in-tolerance condition
- Active LOW power-up reset, 5k $\Omega$  internal pull-up
- Precision temperature-compensated voltage reference and comparator
- Eliminates external components
- Low-cost SOT-223/SO-8/TO-92 packages
- Operating temperature: -40 $^{\circ}$ C to +85 $^{\circ}$ C

**Applications**

- Set-top boxes
- Cellular phones
- PDAs
- Energy management systems
- Embedded control systems
- Printers
- Single board computers

**Typical Operating Circuit**

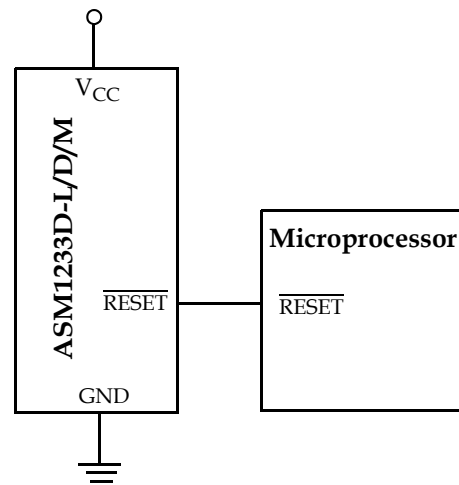

**Block Diagram**

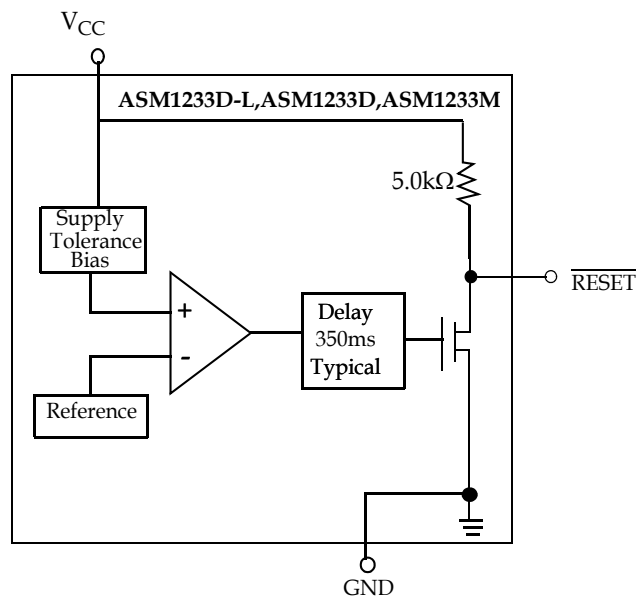



rev 1.3

**Pin Configuration**

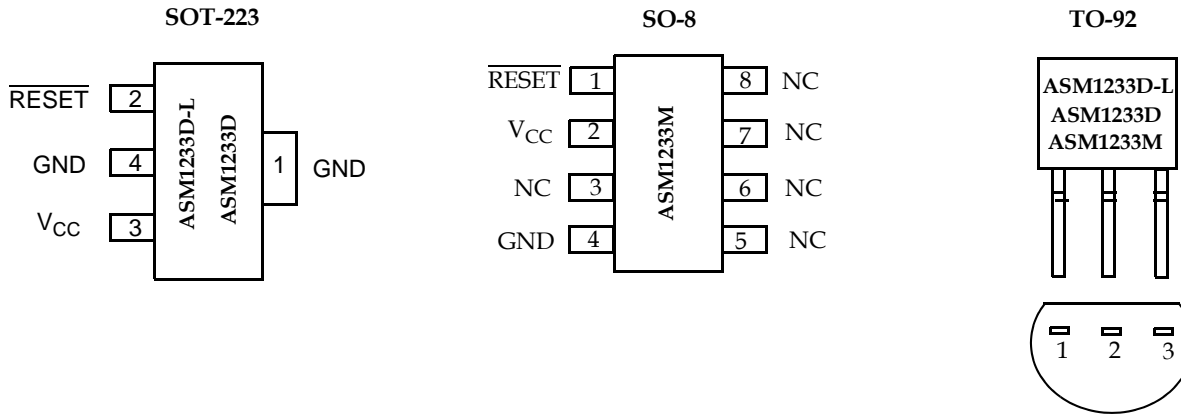

**Pin Description**

Pin#				Pin Name	Description
TO-92 ASM1233D-L ASM1233D	TO-92 ASM1233M	SO-8	SOT-223		
1	3	4	1,4	GND	Ground.
2	1	1	2	RESET	Active LOW reset output.
3	2	2	3	V <sub>CC</sub>	Power supply input.
-	-	3,5,6,7&8	-	NC	No connection



rev 1.3

**Application Information**

**Operation - Power Monitor**

The ASM1233D-L/1233D/1233M detects out-of-tolerance power supply conditions. It resets a processor during power-up, power-down and generates a reset to the system processor when the monitored power supply voltage is below the reset threshold. When an out-of-tolerance  $V_{CC}$  voltage is detected, the  $\overline{\text{RESET}}$  signal is asserted. On power-up,  $\overline{\text{RESET}}$  is kept active (LOW) for approximately 350ms after the power supply voltage has reached the selected tolerance. This allows the power supply and microprocessor to stabilize before  $\overline{\text{RESET}}$  is released.

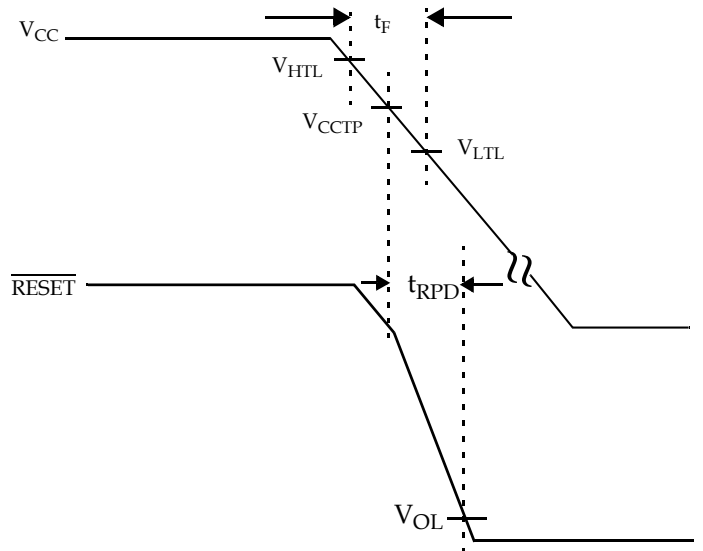

Figure 2: Timing Diagram: Power-Down

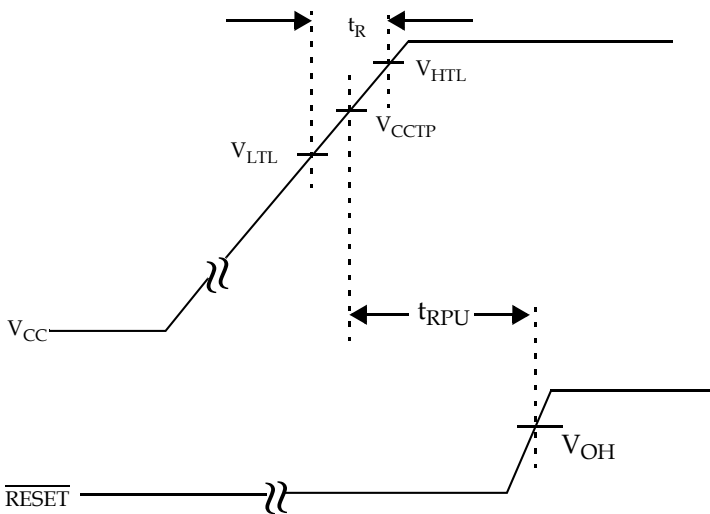

Figure 1: Timing Diagram: Power-Up



rev 1.3

**Absolute Maximum Ratings**

Parameter	Min	Max	Unit
Voltage on $V_{CC}$	-0.5	7	V
Voltage on $\overline{RESET}$	-0.5	$V_{CC} + 0.5$	V
Operating Temperature Range	-40	85	°C
Soldering Temperature (for 10 sec)		260	°C
Storage Temperature	-55	125	°C
ESD rating			
	HBM	2	KV
	MM	200	V

NOTE: These are stress ratings only and functional use is not implied. Exposure to absolute maximum ratings for prolonged periods of time may affect device reliability.



rev 1.3

**Electrical Characteristics**

Unless otherwise noted,  $V_{CC} = 5V \pm 10\%$  and specifications are over the operating temperature range of  $-40^{\circ}C$  to  $+85^{\circ}C$ . All voltages are referenced to ground.

Parameter	Symbol	Conditions	Min	Typ	Max	Unit
Supply Voltage	$V_{CC}$		1.2		5.5	V
Output Voltage	$V_{OL}$	$\overline{RESET}$ asserted	-	-	0.4	V
	$V_{OH}$	$I_{OUT} < 500 \mu A$	$V_{CC}-0.5V$	$V_{CC}-0.1V$		
Output Current	$I_{OL}$	Output = 0.4V	8			mA
Operating Current	$I_{CC}$	$V_{CC} < 5.5V$ , $\overline{RESET}$ output open		8	20	$\mu A$
		$V_{CC} < =3.6V$ , $\overline{RESET}$ output open		6	15	
$V_{CC}$ Trip Point	$V_{CCTP}$	ASM1233D-LZ-5	2.98	3.06	3.15	V
		ASM1233D-LZ-10	2.8	2.88	2.97	
		ASM1233D-LZ-15	2.64	2.72	2.8	
		ASM1233DZ-5	4.5	4.625	4.74	
		ASM1233DZ-10	4.25	4.375	4.49	
		ASM1233DZ-15	4.0	4.125	4.24	
		ASM1233M-5	4.25	4.375	4.49	
		ASM1233M-3	2.64	2.72	2.8	
Voltage High Trip Level	$V_{HTL}$	ASM1233D, ASM1233MS-5, ASM1233MS-55			4.75	V
		ASM1233MS-3			3.14	
		ASM1233D-L			3.06	
Voltage Low Trip Level	$V_{LTL}$	ASM1233D, ASM1233MS-5, ASM1233MS-55			4.00	V
		ASM1233MS-3			2.48	
		ASM1233D-L			2.3	
Internal Pull-up Resistor	$R_P$		3.5	5.0	7.5	k $\Omega$
Output Capacitance	$C_{OUT}$				10	pF
$V_{CC}$ Detect to $\overline{RESET}$ Low	$t_{RPD}$			2	10	$\mu s$
$V_{CC}$ Detect to $\overline{RESET}$ High	$t_{RPU}$	ASM1233D-L, ASM1233M	200	350	500	ms
		ASM1233D	250	350	450	
$V_{CC}$ Slew Rate ( $V_{HTL} - V_{LTL}$ )	$t_F$		300			$\mu s$
$V_{CC}$ Slew Rate ( $V_{LTL} - V_{HTL}$ )	$t_R$		0			ns

Note: A 1k $\Omega$  resistor maybe required in some applications for proper operation of the microprocessor reset control circuit.



rev 1.3

**Family Selection Guide**

Part #	RESET Voltage (V)	RESET Time (ms)	Output Stage	RESET Polarity
ASM1810	4.620, 4.370, 4.120	150	Push-Pull	LOW
ASM1811	4.620, 4.350, 4.130	150	Open-Drain	LOW
ASM1812	4.620, 4.350, 4.130	150	Push-Pull	HIGH
ASM1815	3.060, 2.880, 2.550	150	Push-Pull	LOW
ASM1816	3.060, 2.880, 2.550	150	Open-Drain	LOW
ASM1817	3.060, 2.880, 2.550	150	Push-Pull	HIGH
ASM1233D	4.625, 4.375, 4.125	350	Open-Drain	LOW
ASM1233M	4.625, 4.375, 2.720	350	Open-Drain	LOW
ASM1233D-L	3.06, 2.880, 2.720	350	Open-Drain	LOW



rev 1.3

Package Information

SOT-223

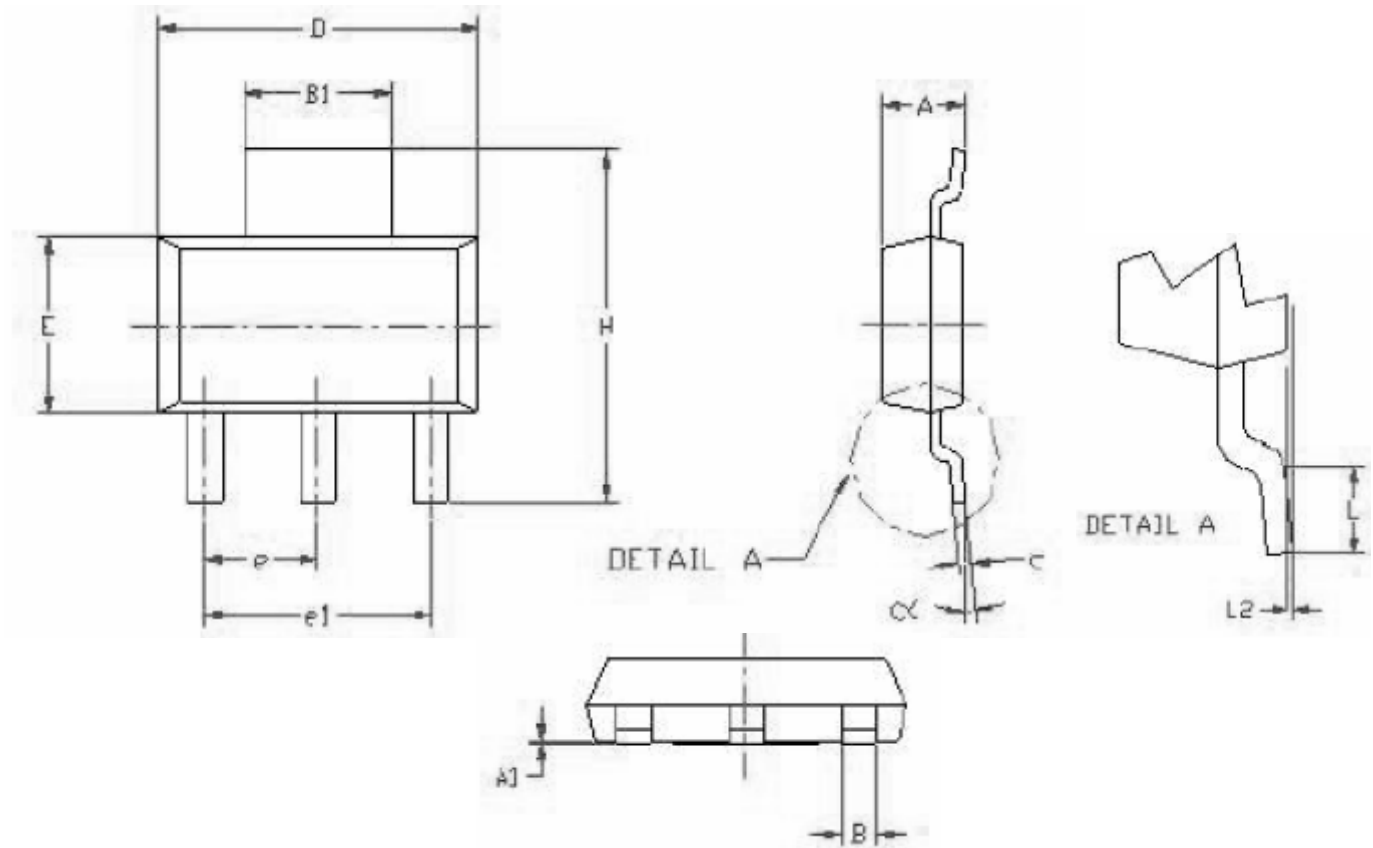

Symbol	Dimensions in Inches		Dimensions in millimeters	
	Min	Max	Min	Max
A	0.061	0.071	1.55	1.80
A1	0.0008	0.004	0.02	0.10
B	0.024	0.031	0.60	0.80
B1	0.114	0.122	2.90	3.10
C	0.009	0.013	0.24	0.32
D	0.248	0.264	6.30	6.70
E	0.130	0.146	3.30	3.70
e	0.090BSC		2.30 BSC	
e1	0.181 BSC		4.60 BSC	
H	0.264	0.287	6.70	7.30
L	0.036 MIN		0.91 MIN	
L2	0.0024 MIN		0.06 BSC	
α	0°	6°	0°	6°



Plastic SO-8 (8-Pin)

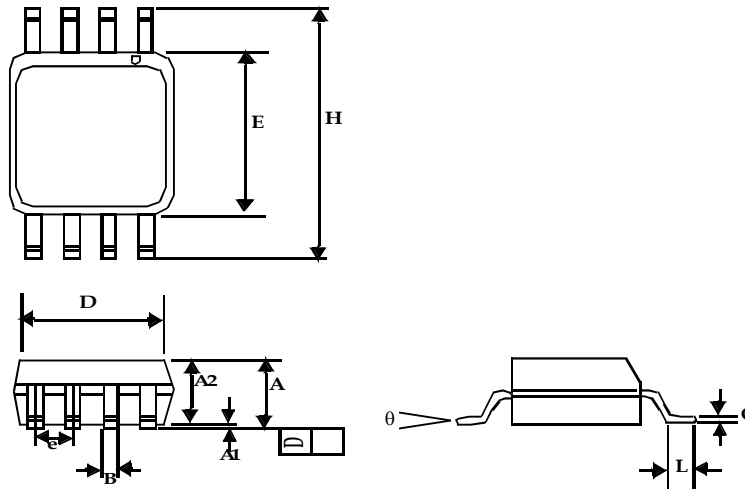

	Dimensions in Inches		Dimensions in Millimeters	
	Min	Max	Min	Max
Plastic SO-8 (8-Pin)				
A	0.053	0.069	1.35	1.75
A1	0.004	0.010	0.10	0.25
A2	0.049	0.059	1.25	1.50
B	0.012	0.020	0.31	0.51
C	0.007	0.010	0.18	0.25
D	0.193 BSC		4.90 BSC	
E	0.154 BSC		3.91 BSC	
e	0.050 BSC		1.27 BSC	
H	0.236 BSC		6.00 BSC	
L	0.016	0.050	0.41	1.27
$\theta$	0°	8°	0°	8°





rev 1.3

To-92 (3-Pin)

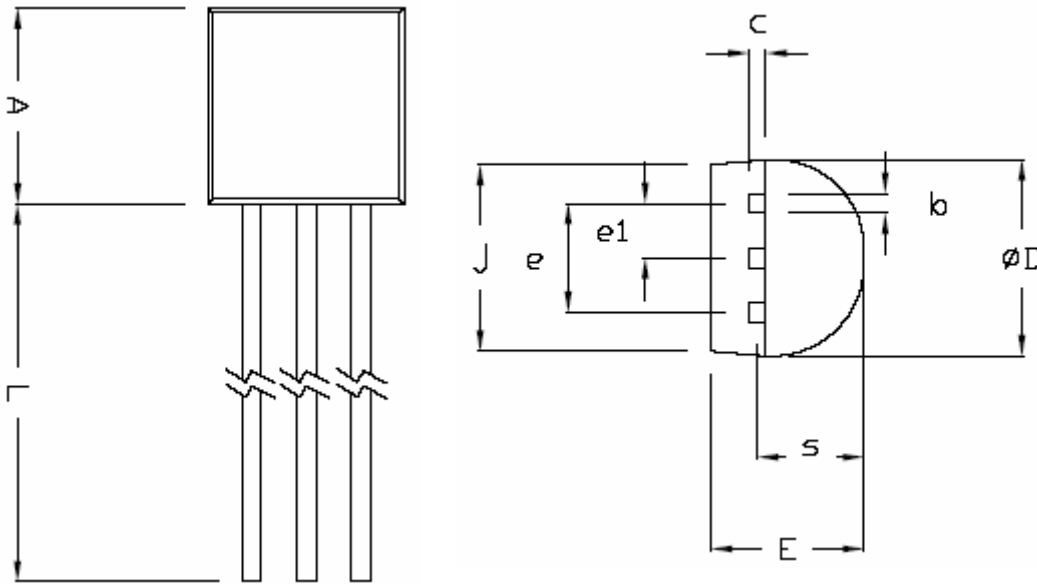

	Dimensions in Inches		Dimensions in Millimeters	
	Min	Max	Min	Max
TO-92				
A	0.175	0.185	4.445	4.699
b	0.016	0.020	0.406	0.508
C	0.014	0.016	0.356	0.406
$\phi D$	0.175	0.185	4.445	4.699
E	0.138	0.144	3.505	3.658
e	0.098	0.102	2.489	2.591
e1	0.045	0.055	1.143	1.397
j	0.168	0.174	4.269	4.420
L	0.500	0.585	12.7	14.86
s	0.095	0.099	2.413	2.515



rev 1.3

Ordering Information

Part Number**	RESET Output Voltage	RESET Tolerance	RESET Time	Open Drain Output Stage*	RESET Polarity	Package	Package Marking
<b>TIN - LEAD DEVICES</b>							
ASM1233D-L-5	3.06	5%	350 ms	◆	LOW	3L TO-92	ASM1233D-L-5
ASM1233D-L-10	2.88	10%	350 ms	◆	LOW	3L TO-92	ASM1233D-L-10
ASM1233D-L-15	2.72	15%	350 ms	◆	LOW	3L TO-92	ASM1233D-L-15
ASM1233D-LZ-5	3.06	5%	350 ms	◆	LOW	4L SOT-223	RVLL
ASM1233D-LZ-10	2.88	10%	350 ms	◆	LOW	4L SOT-223	RWLL
ASM1233D-LZ-15	2.72	15%	350 ms	◆	LOW	4L SOT-223	RXLL
ASM1233D-5	4.625	5%	350 ms	◆	LOW	3L TO-92	ASM1233D-5
ASM1233D-10	4.375	10%	350 ms	◆	LOW	3L TO-92	ASM1233D-10
ASM1233D-15	4.125	15%	350 ms	◆	LOW	3L TO-92	ASM1233D-15
ASM1233DZ-5	4.625	5%	350 ms	◆	LOW	4L SOT-223	RSLL
ASM1233DZ-10	4.375	10%	350 ms	◆	LOW	4L SOT-223	RTLL
ASM1233DZ-15	4.125	15%	350 ms	◆	LOW	4L SOT-223	RULL
ASM1233M-55	4.625	5%	350 ms	◆	LOW	3L TO-92	ASM1233M-55
ASM1233M-5	4.375	10%	350 ms	◆	LOW	3L TO-92	ASM1233M-5
ASM1233M-3	2.72	15%	350 ms	◆	LOW	3L TO-92	ASM1233M-3
ASM1233MS-55	4.625	5%	350 ms	◆	LOW	8L SOIC	ASM1233MS-55
ASM1233MS-5	4.38	10%	350 ms	◆	LOW	8L SOIC	ASM1233MS-5
ASM1233MS-3	2.72	15%	350 ms	◆	LOW	8L SOIC	ASM1233MS-3
<b>LEAD FREE DEVICES</b>							
ASM1233D-L-5F	3.06	5%	350 ms	◆	LOW	3L TO-92	ASM1233D-L-5F
ASM1233D-L-10F	2.88	10%	350 ms	◆	LOW	3L TO-92	ASM1233D-L-10F
ASM1233D-L-15F	2.72	15%	350 ms	◆	LOW	3L TO-92	ASM1233D-L-15F
ASM1233D-LZ-5F	3.06	5%	350 ms	◆	LOW	4L SOT-223	KVLL
ASM1233D-LZ-10F	2.88	10%	350 ms	◆	LOW	4L SOT-223	KWLL
ASM1233D-LZ-15F	2.72	15%	350 ms	◆	LOW	4L SOT-223	KXLL
ASM1233D-5F	4.625	5%	350 ms	◆	LOW	3L TO-92	ASM1233D-5F
ASM1233D-10F	4.375	10%	350 ms	◆	LOW	3L TO-92	ASM1233D-10F
ASM1233D-15F	4.125	15%	350 ms	◆	LOW	3L TO-92	ASM1233D-15F
ASM1233DZ-5F	4.625	5%	350 ms	◆	LOW	4L SOT-223	KSLL
ASM1233DZ-10F	4.375	10%	350 ms	◆	LOW	4L SOT-223	KTLL
ASM1233DZ-15F	4.125	15%	350 ms	◆	LOW	4L SOT-223	KULL
ASM1233M-5F	4.375	5%	350 ms	◆	LOW	3L TO-92	ASM1233M-5F
ASM1233M-55F	4.625	10%	350 ms	◆	LOW	3L TO-92	ASM1233M-55F
ASM1233M-3F	2.72	15%	350 ms	◆	LOW	3L TO-92	ASM1233M-3F
ASM1233MS-5F	4.38	5%	350 ms	◆	LOW	8L SOIC	ASM1233MS-5F
ASM1233MS-55F	4.625	10%	350 ms	◆	LOW	8L SOIC	ASM1233MS-55F
ASM1233MS-3F	2.72	15%	350 ms	◆	LOW	8L SOIC	ASM1233MS-3F



ASM1233D-L/D/M



Alliance Semiconductor Corporation  
2575, Augustine Drive,  
Santa Clara, CA 95054  
Tel: 408 - 855 - 4900  
Fax: 408 - 855 - 4999  
[www.alsc.com](http://www.alsc.com)

Copyright © Alliance Semiconductor  
All Rights Reserved  
Part Number: ASM1233D-L/D/M  
Document Version: 1.3

© Copyright 2003 Alliance Semiconductor Corporation. All rights reserved. Our three-point logo, our name and Intelliwatt are trademarks or registered trademarks of Alliance. All other brand and product names may be the trademarks of their respective companies. Alliance reserves the right to make changes to this document and its products at any time without notice. Alliance assumes no responsibility for any errors that may appear in this document. The data contained herein represents Alliance's best data and/or estimates at the time of issuance. Alliance reserves the right to change or correct this data at any time, without notice. If the product described herein is under development, significant changes to these specifications are possible. The information in this product data sheet is intended to be general descriptive information for potential customers and users, and is not intended to operate as, or provide, any guarantee or warrantee to any user or customer. Alliance does not assume any responsibility or liability arising out of the application or use of any product described herein, and disclaims any express or implied warranties related to the sale and/or use of Alliance products including liability or warranties related to fitness for a particular purpose, merchantability, or infringement of any intellectual property rights, except as express agreed to in Alliance's Terms and Conditions of Sale (which are available from Alliance). All sales of Alliance products are made exclusively according to Alliance's Terms and Conditions of Sale. The purchase of products from Alliance does not convey a license under any patent rights, copyrights; mask works rights, trademarks, or any other intellectual property rights of Alliance or third parties. Alliance does not authorize its products for use as critical components in life-supporting systems where a malfunction or failure may reasonably be expected to result in significant injury to the user, and the inclusion of Alliance products in such life-supporting systems implies that the manufacturer assumes all risk of such use and agrees to indemnify Alliance against all claims arising from such use.