

International IOR Rectifier

111CNQ045A

SCHOTTKY RECTIFIER
New GenIII D-61 Package

110 Amp

Major Ratings and Characteristics



Characteristics	111CNQ045A	Units
$I_{F(AV)}$ Rectangular waveform	110	A
V_{RRM}	45	V
I_{FSM} @tp=5 μ s sine	4000	A
V_F @55Apk, $T_J=125^\circ\text{C}$ (per leg)	0.55	V
T_J range	-55 to 175	$^\circ\text{C}$

Description/Features

The 111CNQ045A center tap Schottky rectifier module has been optimized for very low forward voltage drop, with moderate leakage. The proprietary barrier technology allows for reliable operation up to 175 $^\circ\text{C}$ junction temperature. Typical applications are in switching power supplies, converters, free-wheeling diodes, and reverse battery protection.

- 175 $^\circ\text{C}$ T_J operation
- Center tap module
- Very low forward voltage drop
- High purity, high temperature epoxy encapsulation for enhanced mechanical strength and moisture resistance
- High frequency operation
- Guard ring for enhanced ruggedness and long term reliability
- Low profile, small footprint, high current package
- *New fully transfer-mold low profile, small footprint, high current package*

Case Styles

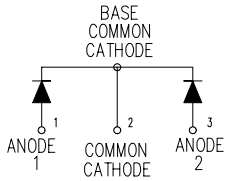
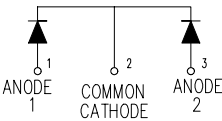
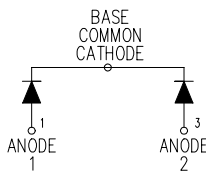
111CNQ045A	111CNQ045ASM	111CNQ045ASL
		
 <p>BASE COMMON CATHODE</p> <p>ANODE 1 COMMON CATHODE 2 ANODE 3</p>	 <p>ANODE 1 COMMON CATHODE 2 ANODE 3</p>	 <p>BASE COMMON CATHODE</p> <p>ANODE 1 ANODE 3</p>
D61-8	D61-8-SM	D61-8-SL

Voltage Ratings

Part number	111CNQ045A
V_R Max. DC Reverse Voltage (V)	45
V_{RWM} Max. Working Peak Reverse Voltage (V)	

Absolute Maximum Ratings

Parameters	111CNQ	Units	Conditions
$I_{F(AV)}$ Max. Average Forward Current * See Fig. 5	55 110	A	50% duty cycle @ $T_C = 152^\circ\text{C}$, rectangular wave form
I_{FSM} Max. Peak One Cycle Non-Repetitive Surge Current (Per Leg) * See Fig. 7	4000 600	A	5 μs Sine or 3 μs Rect. pulse 10ms Sine or 6ms Rect. pulse
E_{AS} Non-Repetitive Avalanche Energy (Per Leg)	54	mJ	$T_J = 25^\circ\text{C}$, $I_{AS} = 8$ Amps, $L = 1.7$ mH
I_{AR} Repetitive Avalanche Current (Per Leg)	8	A	Current decaying linearly to zero in 1 μsec Frequency limited by T_J max. $V_A = 1.5 \times V_R$ typical

Electrical Specifications

Parameters	111CNQ	Units	Conditions
V_{FM} Max. Forward Voltage Drop (Per Leg) (1)	0.61	V	@ 55A
	0.75	V	@ 110A
	0.55	V	@ 55A
	0.69	V	@ 110A
I_{RM} Max. Reverse Leakage Current (Per Leg) (1)	1.5	mA	$T_J = 25^\circ\text{C}$
	65	mA	$T_J = 125^\circ\text{C}$
C_T Max. Junction Capacitance (Per Leg)	3900	pF	$V_R = 5V_{DC}$, (test signal range 100Khz to 1Mhz) 25°C
L_S Typical Series Inductance (Per Leg)	5.5	nH	Measured lead to lead 5mm from package body
dv/dt Max. Voltage Rate of Change (Rated V_R)	10000	V/ μs	

(1) Pulse Width < 300 μs , Duty Cycle <2%

Thermal-Mechanical Specifications

Parameters	111CNQ	Units	Conditions
T_J Max. Junction Temperature Range	-55 to 175	$^\circ\text{C}$	
T_{stg} Max. Storage Temperature Range	-55 to 175	$^\circ\text{C}$	
R_{thJC} Max. Thermal Resistance Junction to Case (Per Leg)	0.5	$^\circ\text{C}/\text{W}$	DC operation
R_{thJC} Max. Thermal Resistance Junction to Case (Per Package)	0.25	$^\circ\text{C}/\text{W}$	DC operation
R_{thCS} Typical Thermal Resistance, Case to Heatsink (D61-8 Only)	0.30	$^\circ\text{C}/\text{W}$	Mounting surface, smooth and greased Device flatness < 5 mils
wt Approximate Weight	7.8(0.28)	g(oz.)	
T Mounting Torque (D61-8 Only)	Min. 40(35)	Kg-cm (lbf-in)	
	Max. 58(50)		

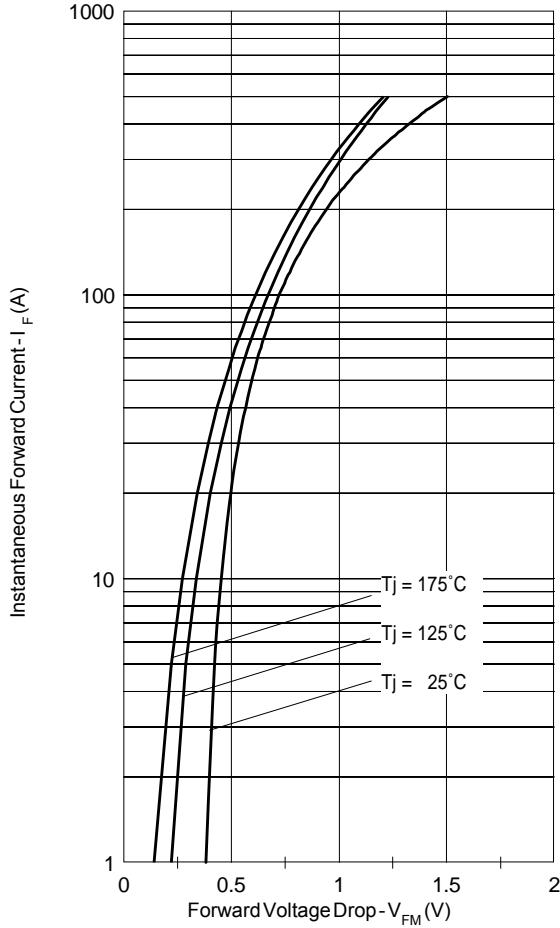

Fig. 1 - Max. Forward Voltage Drop Characteristics (Per Leg)

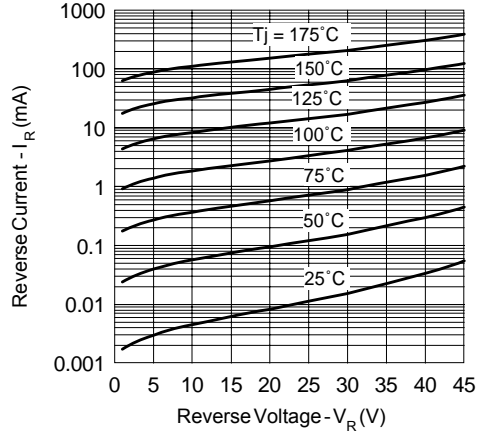

Fig. 2 - Typical Values Of Reverse Current Vs. Reverse Voltage (Per Leg)

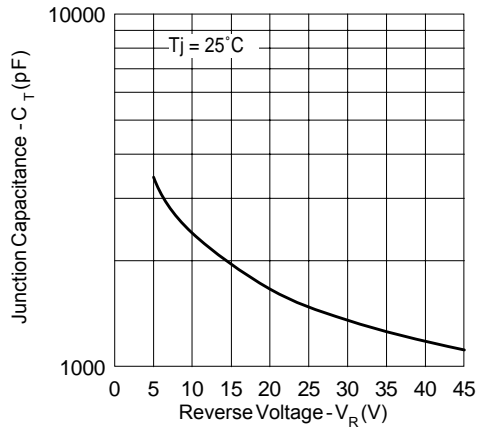

Fig. 3 - Typical Junction Capacitance Vs. Reverse Voltage (Per Leg)

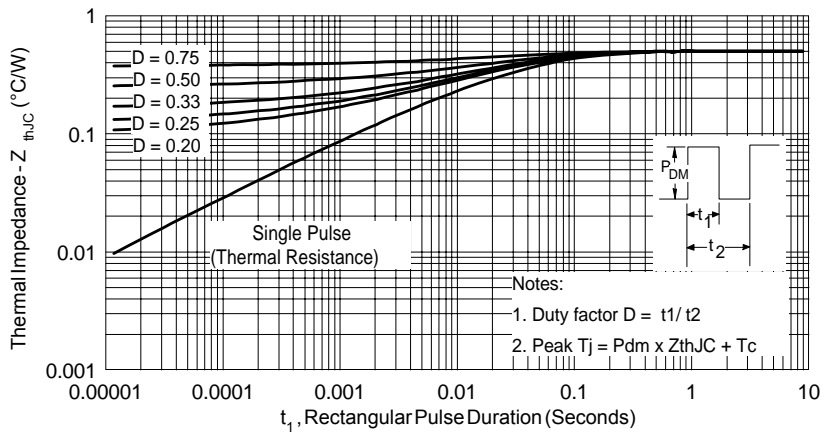

Fig. 4 - Max. Thermal Impedance Z_{thJC} Characteristics (Per Leg)

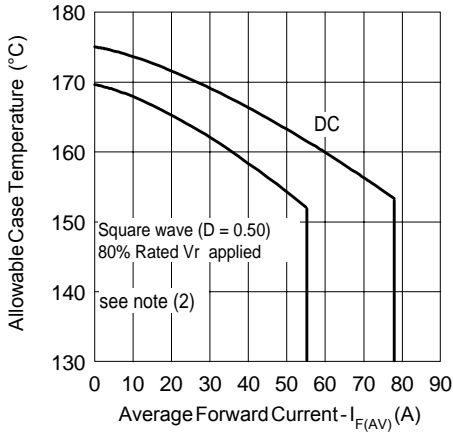

Fig. 5 - Max. Allowable Case Temperature Vs. Average Forward Current (Per Leg)

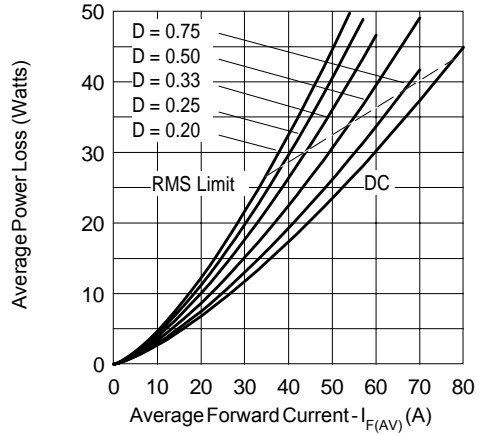

Fig. 6 - Forward Power Loss Characteristics (Per Leg)

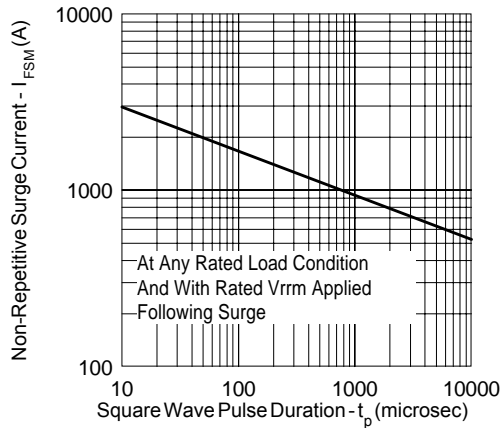

Fig. 7 - Max. Non-Repetitive Surge Current (Per Leg)

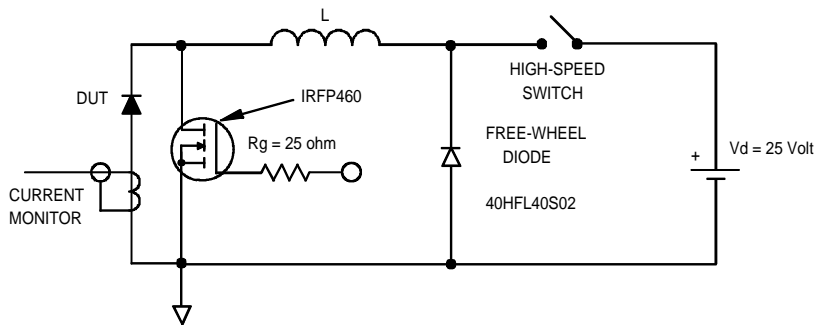

Fig. 8 - Unclamped Inductive Test Circuit

(2) Formula used: $T_c = T_j - (P_d + P_{d_{REV}}) \times R_{thJC}$;

$P_d = \text{Forward Power Loss} = I_{F(AV)} \times V_{FM} @ (I_{F(AV)} / D)$ (see Fig. 6);

$P_{d_{REV}} = \text{Inverse Power Loss} = V_{R1} \times I_R (1 - D)$; $I_R @ V_{R1} = 80\% \text{ rated } V_R$

Outline Table

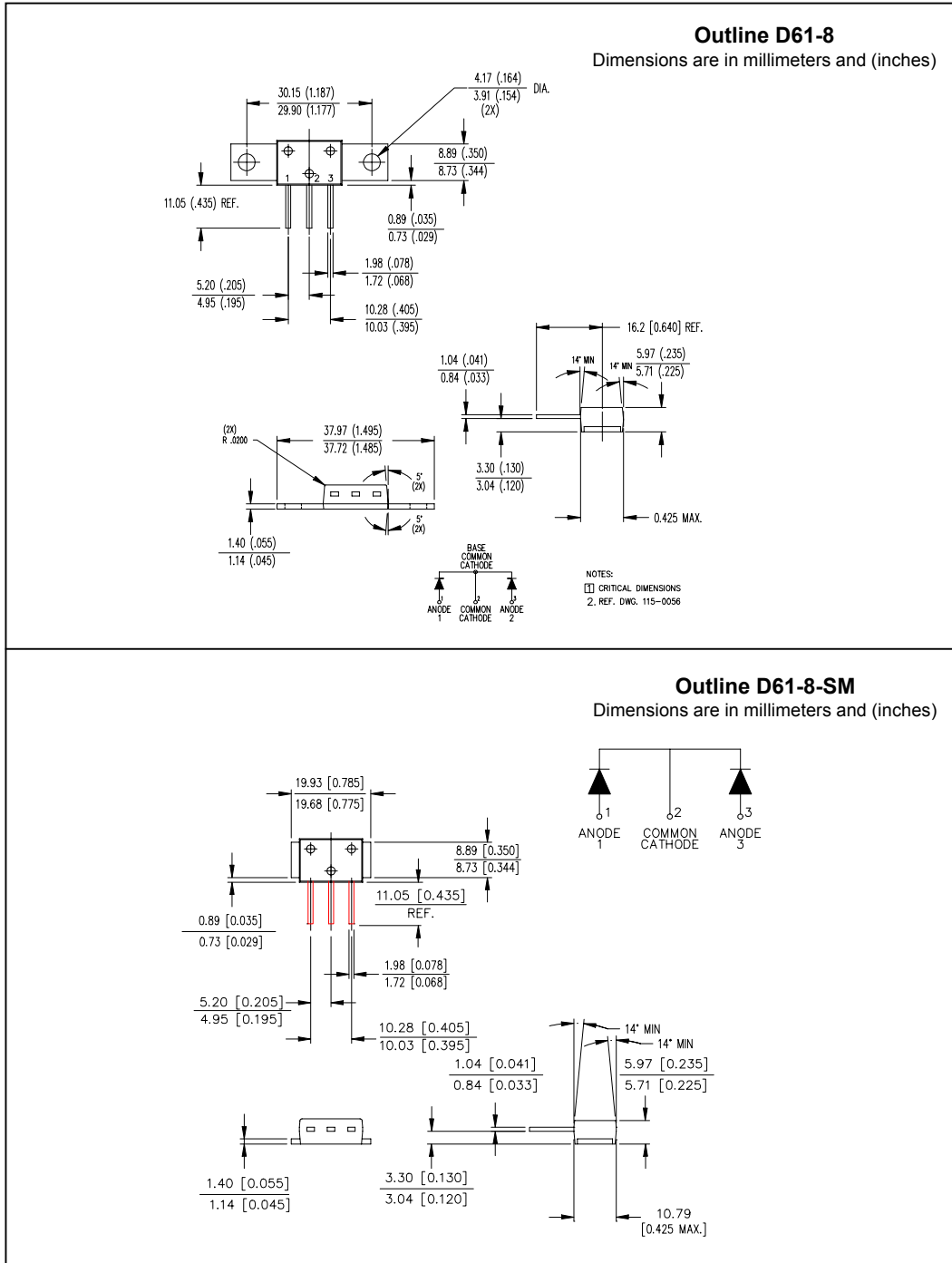

Outline D61-8-SM
 Dimensions are in millimeters and (inches)

Outline Table

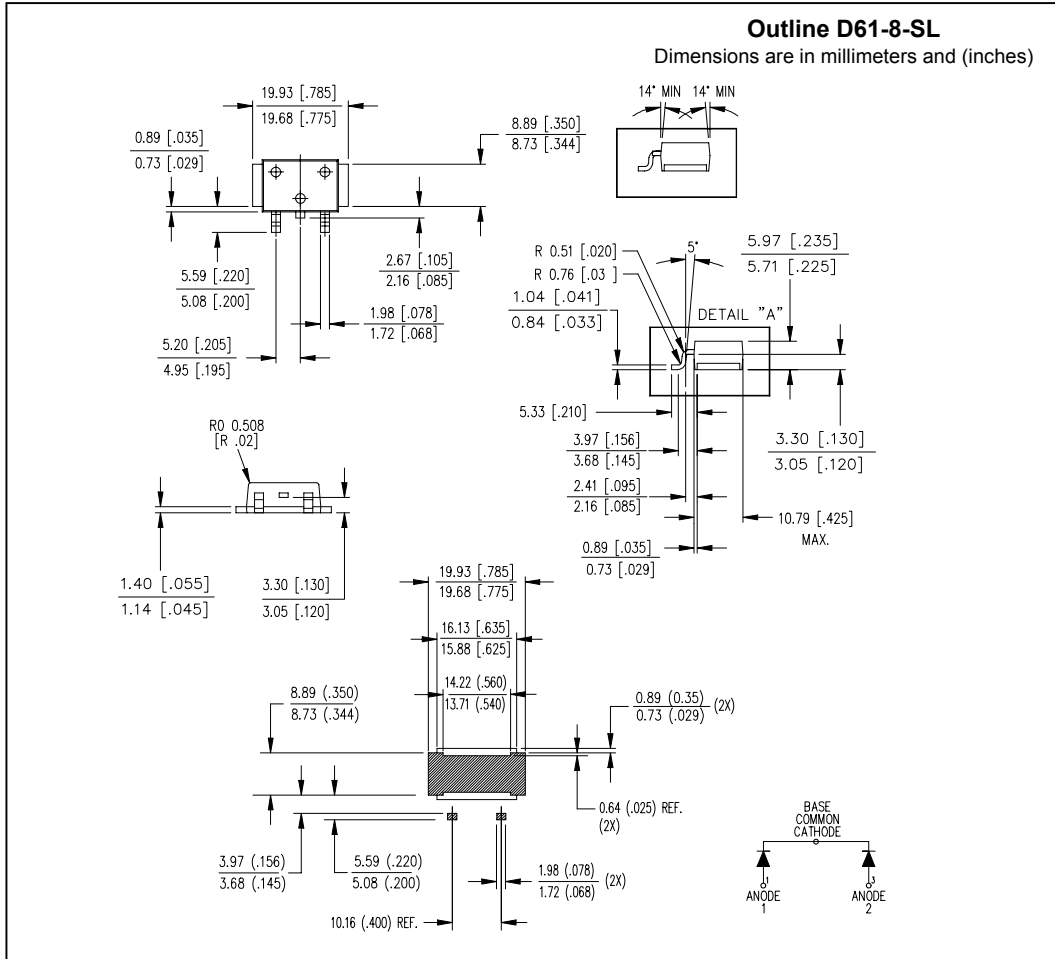

Marking Information

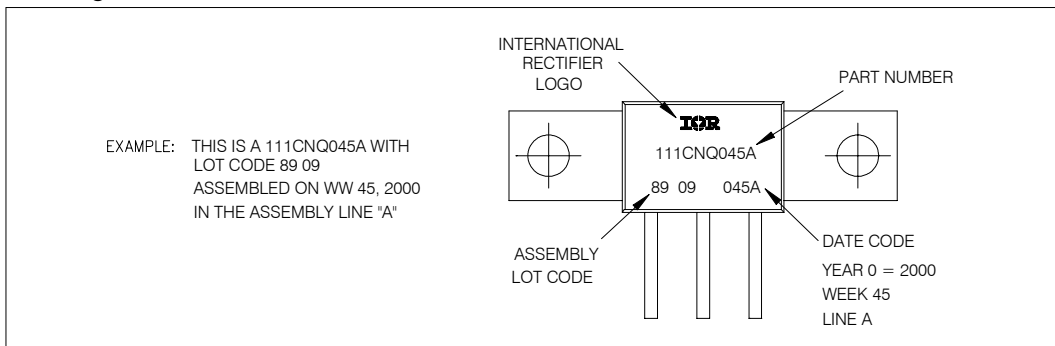

Data and specifications subject to change without notice.
This product has been designed and qualified for Industrial Level.
Qualification Standards can be found on IR's Web site.

International
IOR Rectifier

IR WORLD HEADQUARTERS: 233 Kansas St., El Segundo, California 90245, USA Tel: (310) 252-7105
TAC Fax: (310) 252-7309
Visit us at www.irf.com for sales contact information. 03/02