

REPETITIVE AVALANCHE AND dv/dt RATED HEXFET[®] TRANSISTORS THRU-HOLE (TO-204AA/AE)

IRF034 60V, N-CHANNEL

Product Summary

| Part Number | BVDSS | RDS(on) | ID |
|-------------|-------|---------|-----|
| IRF034 | 60V | 0.050Ω | 25A |

The HEXFET[®] technology is the key to International Rectifier's advanced line of power MOSFET transistors. The efficient geometry and unique processing of this latest "State of the Art" design achieves: very low on-state resistance combined with high transconductance; superior reverse energy and diode recovery dv/dt capability.

The HEXFET transistors also feature all of the well established advantages of MOSFETs such as voltage control, very fast switching, ease of paralleling and temperature stability of the electrical parameters.

They are well suited for applications such as switching power supplies, motor controls, inverters, choppers, audio amplifiers and high energy pulse circuits.



Features:

- Repetitive Avalanche Ratings
- Dynamic dv/dt Rating
- Hermetically Sealed
- Simple Drive Requirements
- Ease of Paralleling

Absolute Maximum Ratings

| | Parameter | | Units |
|---------------------------|---------------------------------|---|-------|
| ID @ VGS = 0V, TC = 25°C | Continuous Drain Current | 25 | A |
| ID @ VGS = 0V, TC = 100°C | Continuous Drain Current | 16 | |
| IDM | Pulsed Drain Current ① | 100 | |
| PD @ TC = 25°C | Max. Power Dissipation | 75 | W |
| | Linear Derating Factor | 0.60 | W/°C |
| VGS | Gate-to-Source Voltage | ±20 | V |
| EAS | Single Pulse Avalanche Energy ② | 19 | mJ |
| IAR | Avalanche Current ① | - | A |
| EAR | Repetitive Avalanche Energy ① | - | mJ |
| dv/dt | Peak Diode Recovery dv/dt ③ | 4.5 | V/ns |
| TJ | Operating Junction | -55 to 150 | °C |
| TSTG | Storage Temperature Range | | |
| | Lead Temperature | 300 (0.063 in. (1.6mm) from case for 10s) | |
| | Weight | 11.5(typical) | g |

For footnotes refer to the last page

Electrical Characteristics @ T_j = 25°C (Unless Otherwise Specified)

| | Parameter | Min | Typ | Max | Units | Test Conditions |
|-------------------------------------|--|-----|------|-------|-------|---|
| BV _{DSS} | Drain-to-Source Breakdown Voltage | 60 | — | — | V | V _{GS} = 0V, I _D = 1.0mA |
| ΔBV _{DSS} /ΔT _j | Temperature Coefficient of Breakdown Voltage | — | 0.68 | — | V/°C | Reference to 25°C, I _D = 1.0mA |
| R _{DSS(on)} | Static Drain-to-Source On-State Resistance | — | — | 0.050 | Ω | V _{GS} = 10V, I _D = 16A④ |
| | | — | — | 0.058 | | V _{GS} = 10V, I _D = 25A ④ |
| V _{GS(th)} | Gate Threshold Voltage | 2.0 | — | 4.0 | V | V _{DS} = V _{GS} , I _D = 250μA |
| g _{fs} | Forward Transconductance | 9.3 | — | — | S (Ω) | V _{DS} > 15V, I _{DS} = 16A④ |
| I _{DSS} | Zero Gate Voltage Drain Current | — | — | 25 | μA | V _{DS} = 48V, V _{GS} = 0V |
| | | — | — | 250 | | V _{DS} = 48V V _{GS} = 0V, T _j = 125°C |
| I _{GSS} | Gate-to-Source Leakage Forward | — | — | 100 | nA | V _{GS} = 20V |
| I _{GSS} | Gate-to-Source Leakage Reverse | — | — | -100 | | V _{GS} = -20V |
| Q _g | Total Gate Charge | 21 | — | 47 | nC | V _{GS} = 10V, I _D = 25A |
| Q _{gs} | Gate-to-Source Charge | 4.4 | — | 10 | | V _{DS} = 30V |
| Q _{gd} | Gate-to-Drain ('Miller') Charge | 9.7 | — | 22 | | |
| t _{d(on)} | Turn-On Delay Time | — | — | 21 | n s | V _{DD} = 30V, I _D = 25A, R _G = 7.5Ω |
| t _r | Rise Time | — | — | 110 | | |
| t _{d(off)} | Turn-Off Delay Time | — | — | 53 | | |
| t _f | Fall Time | — | — | 80 | | |
| L _S + L _D | Total Inductance | — | 6.1 | — | nH | Measured from drain lead (6mm/0.25in. from package) to source lead (6mm/0.25in. from package) |
| C _{iss} | Input Capacitance | — | 1300 | — | pF | V _{GS} = 0V, V _{DS} = 25V f = 1.0MHz |
| C _{oss} | Output Capacitance | — | 650 | — | | |
| C _{rss} | Reverse Transfer Capacitance | — | 100 | — | | |

Source-Drain Diode Ratings and Characteristics

| | Parameter | Min | Typ | Max | Units | Test Conditions |
|-----------------|--|--|-----|-----|-------|---|
| I _S | Continuous Source Current (Body Diode) | — | — | 25 | A | |
| I _{SM} | Pulse Source Current (Body Diode) ① | — | — | 100 | | |
| V _{SD} | Diode Forward Voltage | — | — | 1.8 | V | T _j = 25°C, I _S = 25A, V _{GS} = 0V ④ |
| t _{rr} | Reverse Recovery Time | — | — | 220 | nS | T _j = 25°C, I _F = 25A, di/dt ≤ 100A/μs |
| Q _{RR} | Reverse Recovery Charge | — | — | 9.6 | μC | V _{DD} ≤ 50V ④ |
| t _{on} | Forward Turn-On Time | Intrinsic turn-on time is negligible. Turn-on speed is substantially controlled by L _S + L _D . | | | | |

Thermal Resistance

| | Parameter | Min | Typ | Max | Units | Test Conditions |
|-------------------|---------------------|-----|-----|------|-------|----------------------|
| R _{thJC} | Junction to Case | — | — | 1.67 | °C/W | Typical socket mount |
| R _{thJA} | Junction to Ambient | — | — | 30 | | |

For footnotes refer to the last page

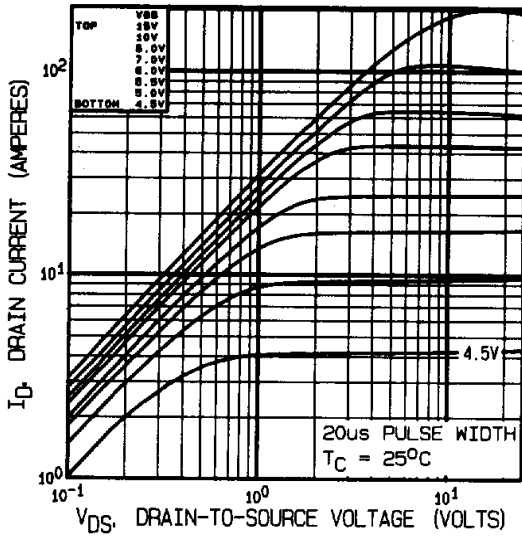

Fig 1. Typical Output Characteristics

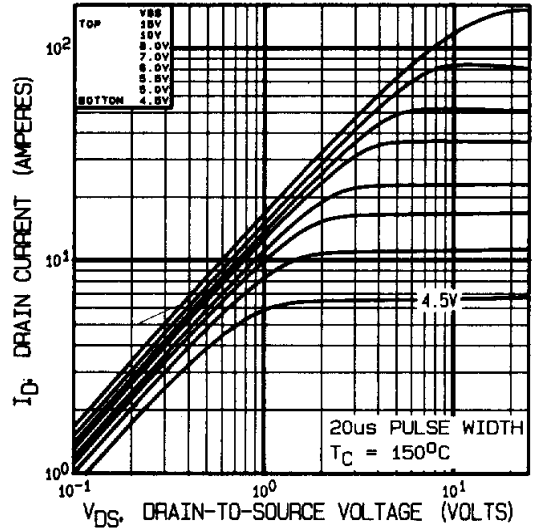

Fig 2. Typical Output Characteristics

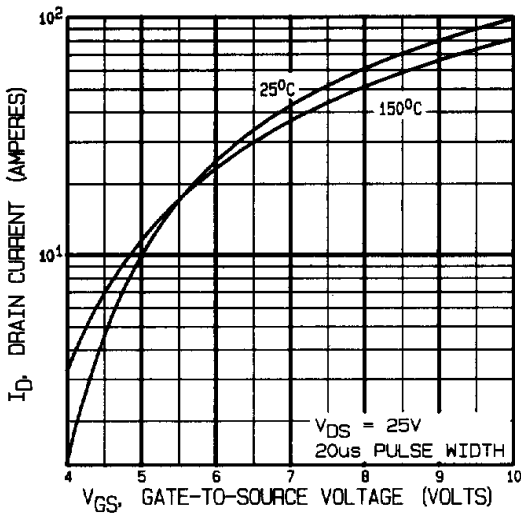

Fig 3. Typical Transfer Characteristics

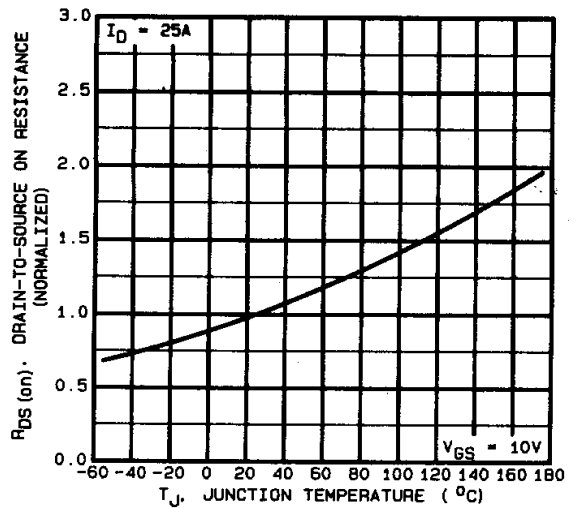

Fig 4. Normalized On-Resistance Vs. Temperature

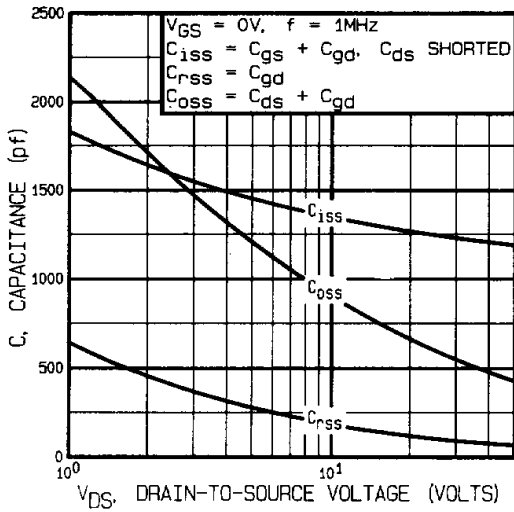

Fig 5. Typical Capacitance Vs. Drain-to-Source Voltage

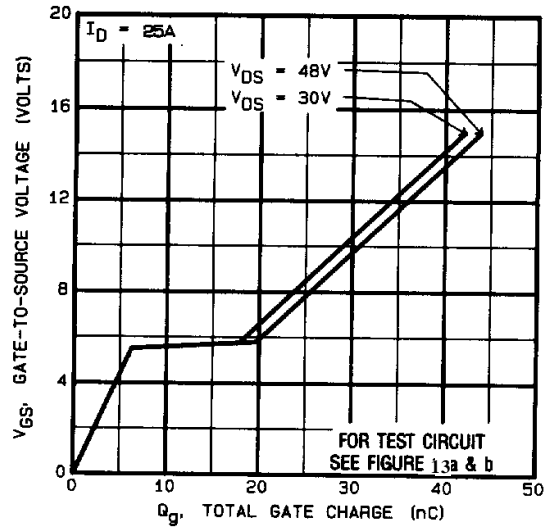

Fig 6. Typical Gate Charge Vs. Gate-to-Source Voltage

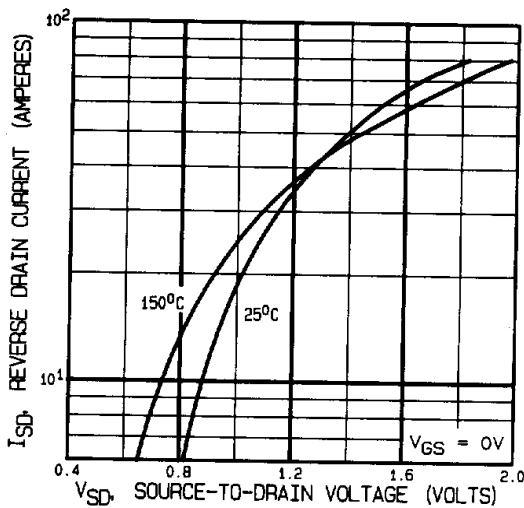

Fig 7. Typical Source-Drain Diode Forward Voltage

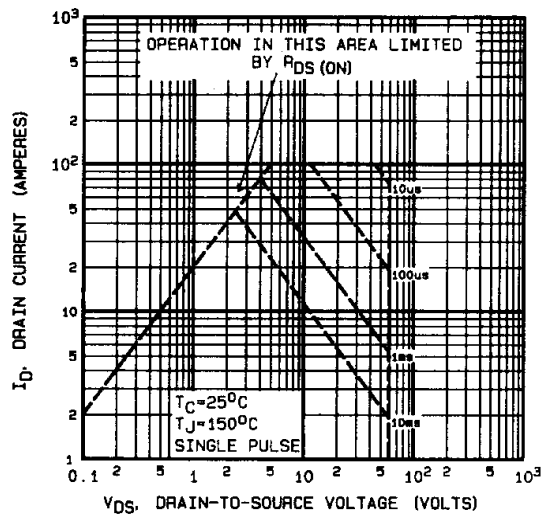

Fig 8. Maximum Safe Operating Area

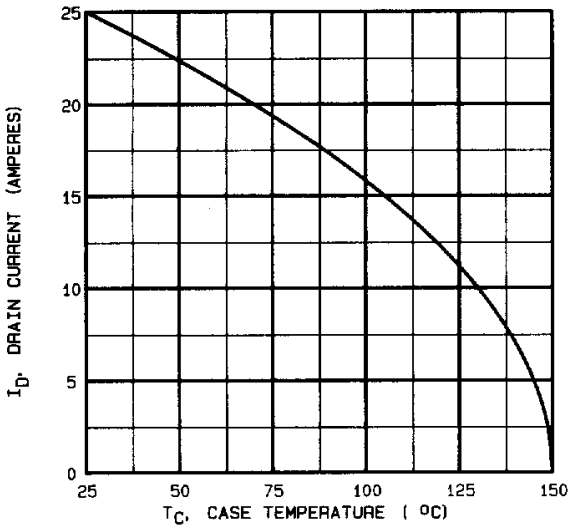

Fig 9. Maximum Drain Current Vs. Case Temperature

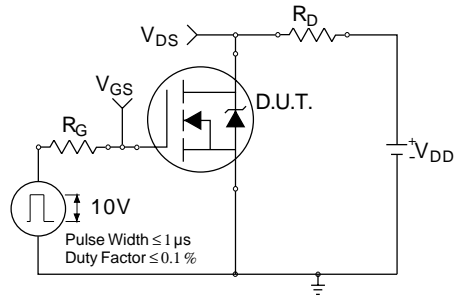

Fig 10a. Switching Time Test Circuit

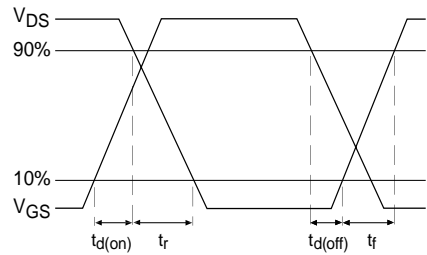

Fig 10b. Switching Time Waveforms

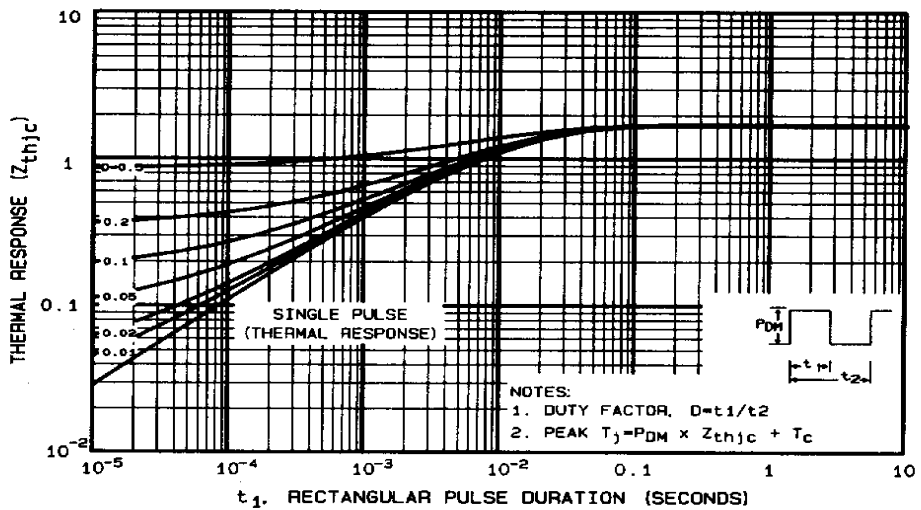

Fig 11. Maximum Effective Transient Thermal Impedance, Junction-to-Case

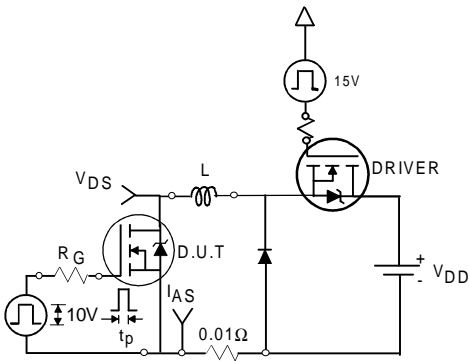

Fig 12a. Unclamped Inductive Test Circuit

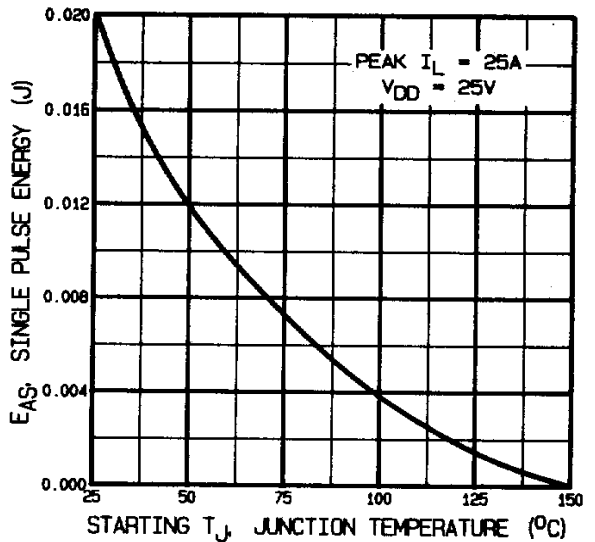

Fig 12c. Maximum Avalanche Energy Vs. Drain Current

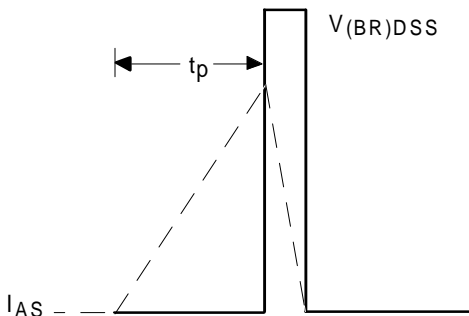

Fig 12b. Unclamped Inductive Waveforms

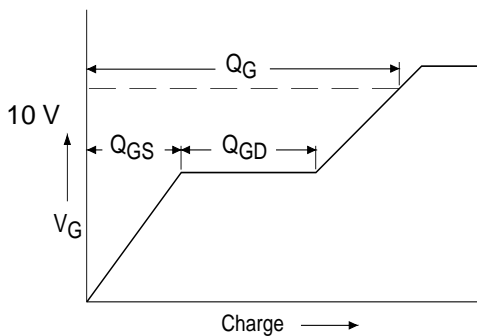

Fig 13a. Basic Gate Charge Waveform

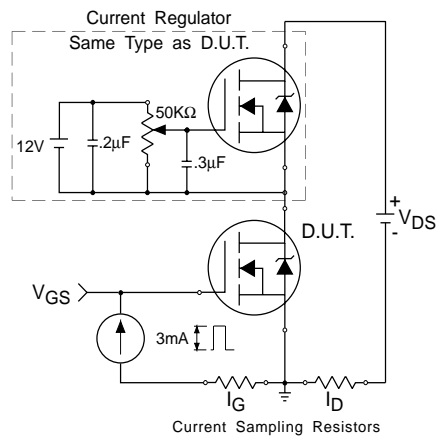
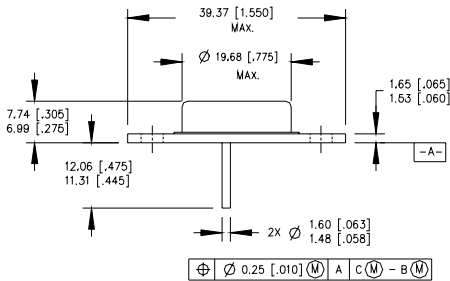

Fig 13b. Gate Charge Test Circuit

Foot Notes:

- ① Repetitive Rating; Pulse width limited by maximum junction temperature.
- ② $V_{DD} = 25V$, starting $T_J = 25^{\circ}C$,
Peak $I_L = 25A$,
- ③ $I_{SD} \leq 25A$, $di/dt \leq 200A/\mu s$,
 $V_{DD} \leq 60V$, $T_J \leq 150^{\circ}C$
Suggested $R_G = 7.5 \Omega$
- ④ Pulse width $\leq 300 \mu s$; Duty Cycle $\leq 2\%$

Case Outline and Dimensions —TO-204AE (Modified TO-3)



PIN ASSIGNMENTS

- 1 - SOURCE
- 2 - GATE
- 3 - DRAIN (CASE)

NOTES:

1. DIMENSIONING & TOLERANCING PER ANSI Y14.6M-1982.
2. CONTROLLING DIMENSION: INCH.
3. DIMENSIONS ARE SHOWN IN MILLIMETERS [INCHES].
4. OUTLINE CONFORMS TO JEDEC OUTLINE TO-204AE.

