

International IR Rectifier

**REPETITIVE AVALANCHE AND dv/dt RATED
HEXFET[®] TRANSISTORS
SURFACE MOUNT (LCC-18)**

**IRFE210
JANTX2N6784U
JANTXV2N6784U
[REF: MIL-PRF-19500/556]
200V, N-CHANNEL**

Product Summary

Part Number	BVDSS	RDS(on)	ID
IRFE210	200V	1.5 Ω	2.25A



The leadless chip carrier (LCC) package represents the logical next step in the continual evolution of surface mount technology. Designed to be a close replacement for the TO-39 package, the LCC will give designers the extra flexibility they need to increase circuit board density. International Rectifier has engineered the LCC package to meet the specific needs of the power market by increasing the size of the bottom source pad, thereby enhancing the thermal and electrical performance. The lid of the package is grounded to the source to reduce RF interference.

Features:

- Surface Mount
- Small Footprint
- Alternative to TO-39 Package
- Hermetically Sealed
- Dynamic dv/dt Rating
- Avalanche Energy Rating
- Simple Drive Requirements
- Light Weight

Absolute Maximum Ratings

	Parameter		Units
ID @ VGS = 10V, TC = 25°C	Continuous Drain Current	2.25	A
ID @ VGS = 10V, TC = 100°C	Continuous Drain Current	1.5	
IDM	Pulsed Drain Current ①	9.0	
PD @ TC = 25°C	Max. Power Dissipation	15	W
	Linear Derating Factor	0.12	W/°C
VGS	Gate-to-Source Voltage	±20	V
EAS	Single Pulse Avalanche Energy ②	20	mJ
IAR	Avalanche Current ①	-	A
EAR	Repetitive Avalanche Energy ①	-	mJ
dv/dt	Peak Diode Recovery dv/dt ③	3.9	V/ns
TJ	Operating Junction	-55 to 150	°C
TSTG	Storage Temperature Range		
	Pckg. Mounting Surface Temp.	300 (for 5 S)	
	Weight	0.42(typical)	g

For footnotes refer to the last page

Electrical Characteristics @ T_j = 25°C (Unless Otherwise Specified)

	Parameter	Min	Typ	Max	Units	Test Conditions
BVDSS	Drain-to-Source Breakdown Voltage	200	—	—	V	V _{GS} = 0V, I _D = 1.0mA
ΔBVDSS/ΔT _j	Temperature Coefficient of Breakdown Voltage	—	0.23	—	V/°C	Reference to 25°C, I _D = 1.0mA
RDS(on)	Static Drain-to-Source On-State Resistance	—	—	1.5	Ω	V _{GS} = 10V, I _D = 1.5A④
		—	—	1.725		V _{GS} = 10V, I _D = 2.25A ④
VGS(th)	Gate Threshold Voltage	2.0	—	4.0	V	V _{DS} = V _{GS} , I _D = 250μA
g _{fs}	Forward Transconductance	1.4	—	—	S (Ω)	V _{DS} > 15V, I _{DS} = 1.5A④
IDSS	Zero Gate Voltage Drain Current	—	—	25	μA	V _{DS} = 160V, V _{GS} = 0V
		—	—	250		V _{DS} = 160V V _{GS} = 0V, T _j = 125°C
IGSS	Gate-to-Source Leakage Forward	—	—	100	nA	V _{GS} = 20V
IGSS	Gate-to-Source Leakage Reverse	—	—	-100		V _{GS} = -20V
Q _g	Total Gate Charge	—	—	6.2	nC	V _{GS} = 10V, I _D = 2.25A V _{DS} = 100V
Q _{gs}	Gate-to-Source Charge	—	—	1.2		
Q _{gd}	Gate-to-Drain ('Miller') Charge	—	—	5.0		
t _{d(on)}	Turn-On Delay Time	—	—	15	ns	V _{DD} = 100V, I _D = 2.25A, R _G = 7.5Ω
t _r	Rise Time	—	—	20		
t _{d(off)}	Turn-Off Delay Time	—	—	30		
t _f	Fall Time	—	—	20		
L _S + L _D	Total Inductance	—	6.1	—	nH	Measured from the center of drain pad to center of source pad
C _{iss}	Input Capacitance	—	150	—	pF	V _{GS} = 0V, V _{DS} = 25V f = 1.0MHz
C _{oss}	Output Capacitance	—	57	—		
C _{rss}	Reverse Transfer Capacitance	—	15	—		

Source-Drain Diode Ratings and Characteristics

	Parameter	Min	Typ	Max	Units	Test Conditions
I _S	Continuous Source Current (Body Diode)	—	—	2.25	A	
I _{SM}	Pulse Source Current (Body Diode) ①	—	—	9.0		
V _{SD}	Diode Forward Voltage	—	—	1.5	V	T _j = 25°C, I _S = 2.25A, V _{GS} = 0V ④
t _{rr}	Reverse Recovery Time	—	—	350	nS	T _j = 25°C, I _F = 2.25A, di/dt ≤ 100A/μs
QRR	Reverse Recovery Charge	—	—	0.66	μC	V _{DD} ≤ 50V ④
t _{on}	Forward Turn-On Time	Intrinsic turn-on time is negligible. Turn-on speed is substantially controlled by L _S + L _D .				

Thermal Resistance

	Parameter	Min	Typ	Max	Units	Test Conditions
R _{thJC}	Junction to Case	—	—	8.3	°C/W	Soldered to a copper clad PC board
R _{thJ-PCB}	Junction to PC Board	—	—	27		

For footnotes refer to the last page

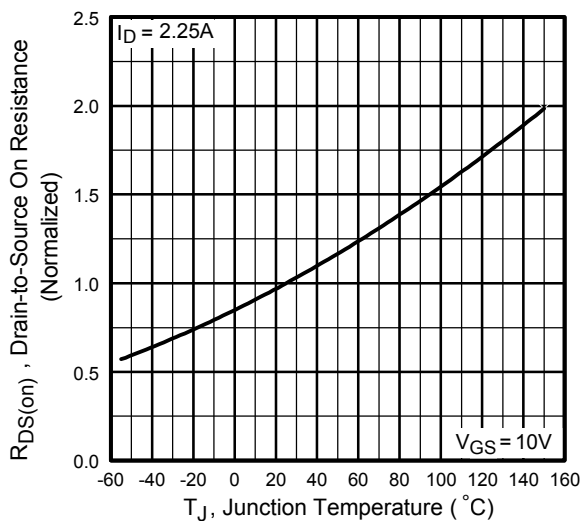
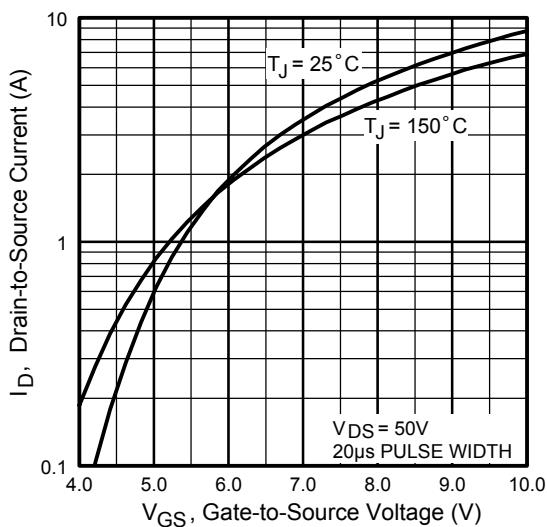
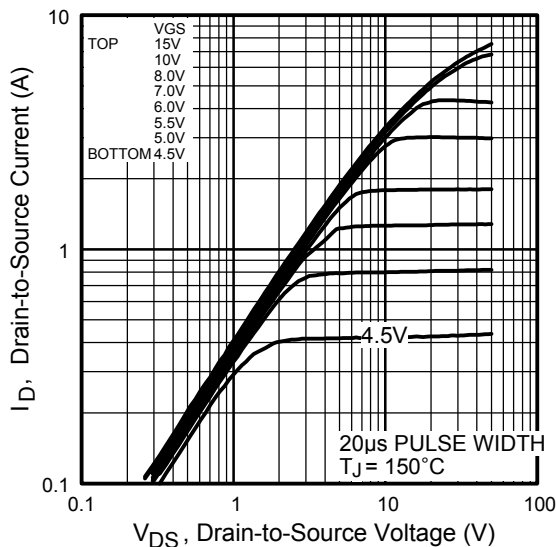
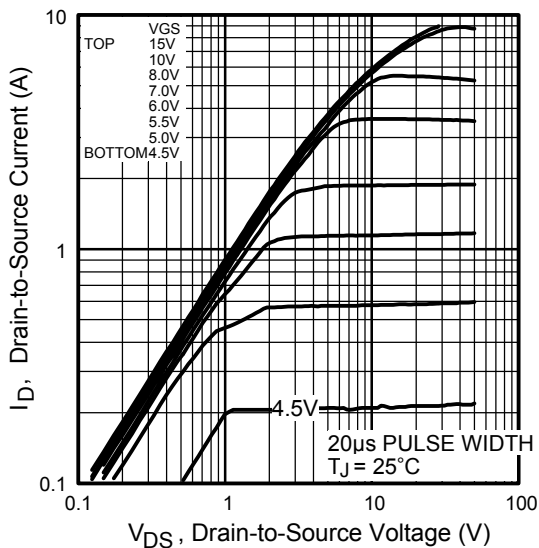

Fig 3. Typical Transfer Characteristics

Fig 4. Normalized On-Resistance Vs. Temperature

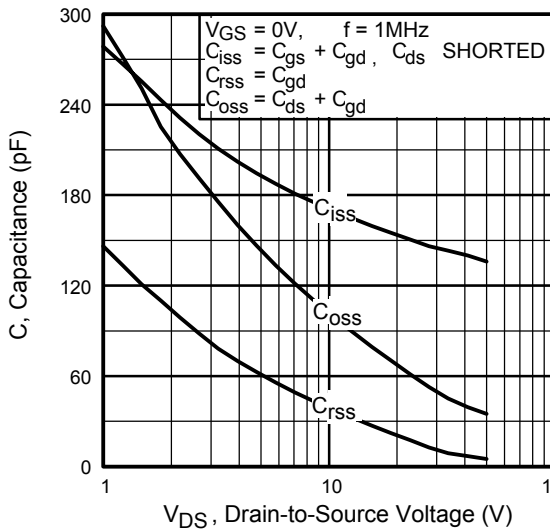

Fig 5. Typical Capacitance Vs. Drain-to-Source Voltage

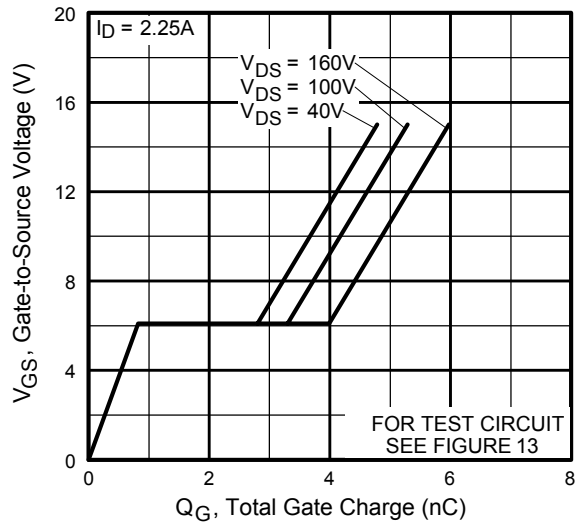

Fig 6. Typical Gate Charge Vs. Gate-to-Source Voltage

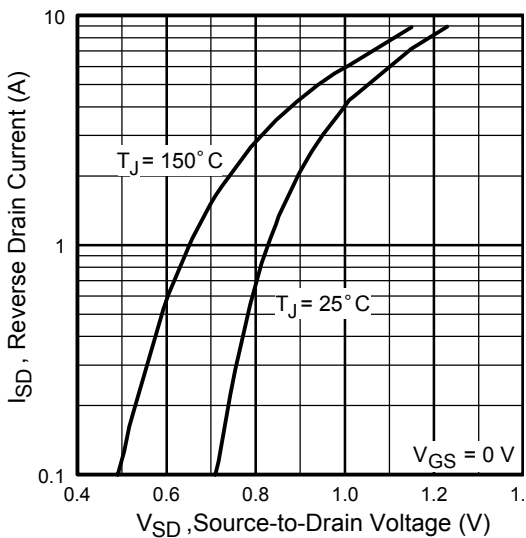

Fig 7. Typical Source-Drain Diode Forward Voltage

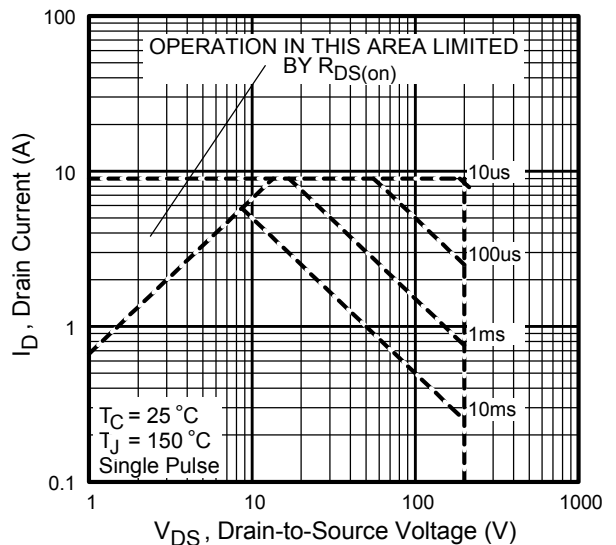

Fig 8. Maximum Safe Operating Area

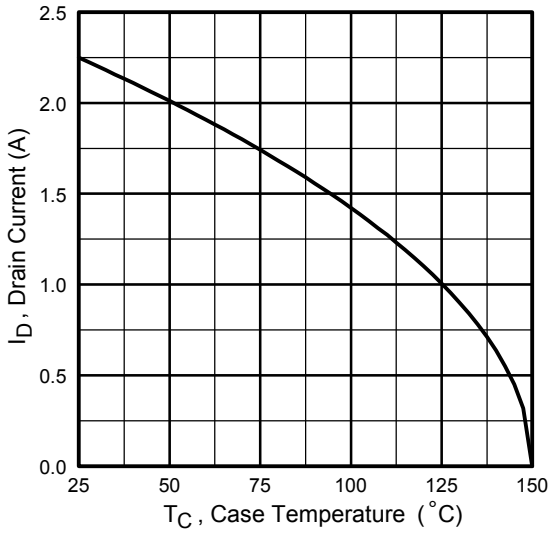

Fig 9. Maximum Drain Current Vs. Case Temperature

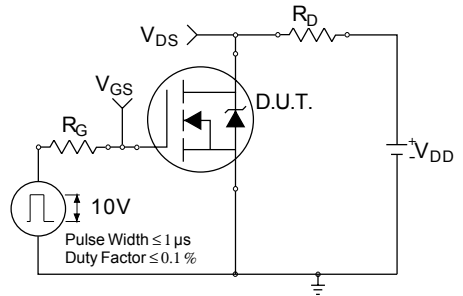

Fig 10a. Switching Time Test Circuit



Fig 10b. Switching Time Waveforms

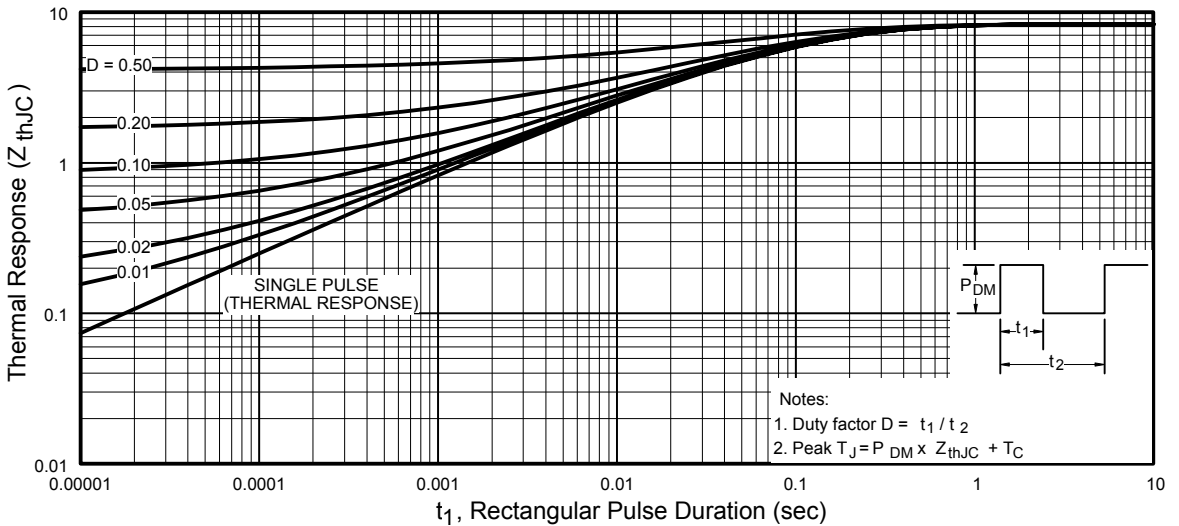

Fig 11. Maximum Effective Transient Thermal Impedance, Junction-to-Case

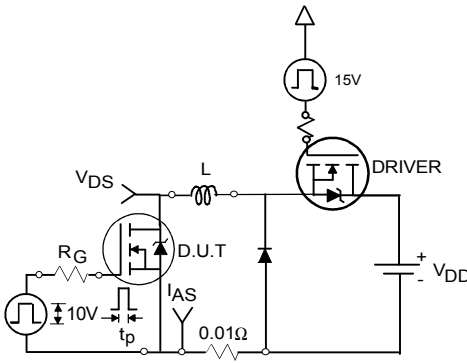

Fig 12a. Unclamped Inductive Test Circuit

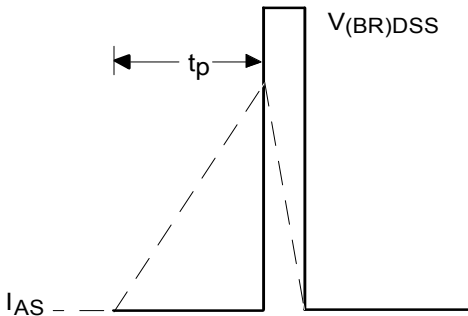

Fig 12b. Unclamped Inductive Waveforms

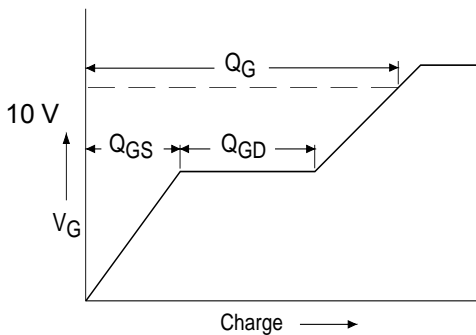

Fig 13a. Basic Gate Charge Waveform

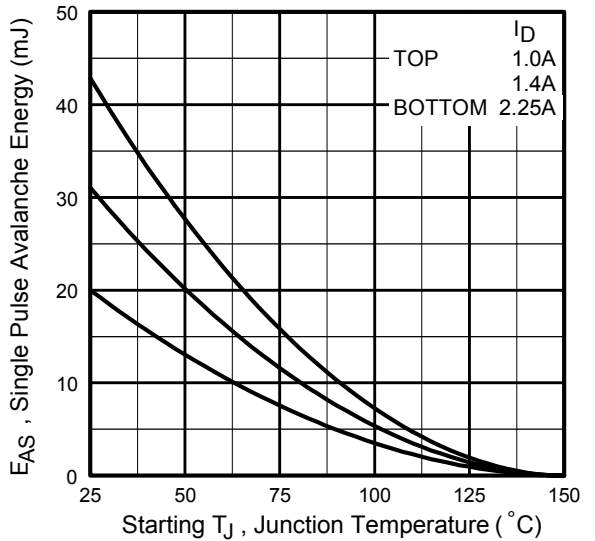

Fig 12c. Maximum Avalanche Energy Vs. Drain Current

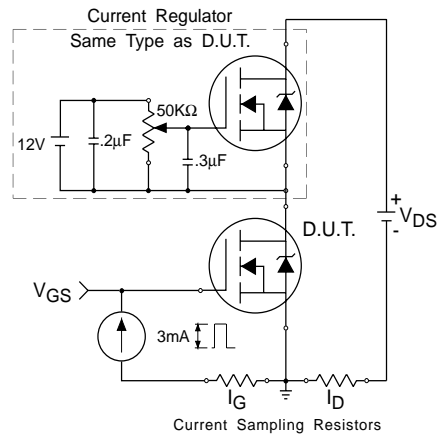
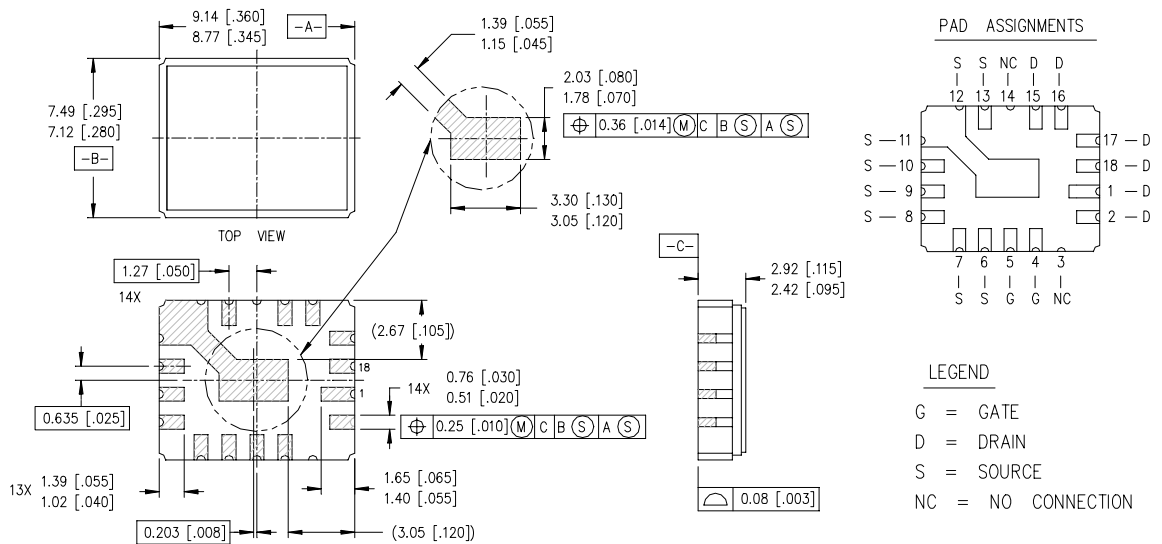

Fig 13b. Gate Charge Test Circuit

Foot Notes:

- ① Repetitive Rating; Pulse width limited by maximum junction temperature.
- ② $V_{DD} = 50V$, starting $T_J = 25^{\circ}C$,
Peak $I_L = 2.25A$,
- ③ $I_{SD} \leq 2.25A$, $di/dt \leq 70A/\mu s$,
 $V_{DD} \leq 200V$, $T_J \leq 150^{\circ}C$
Suggested $R_G = 7.5 \Omega$
- ④ Pulse width $\leq 300 \mu s$; Duty Cycle $\leq 2\%$

Case Outline and Dimensions — LCC-18



NOTES:

1. DIMENSIONING & TOLERANCING PER ANSI Y14.5M-1982.
2. CONTROLLING DIMENSION: INCH.
3. DIMENSIONS ARE SHOWN IN MILLIMETERS [INCHES].