

# 54ABT244

## Octal Buffer/Line Driver with TRI-STATE® Outputs

### General Description

The 'ABT244 is an octal buffer and line driver with TRI-STATE outputs designed to be employed as a memory and address driver, clock driver, or bus-oriented transmitter/receiver.

### Features

- Non-inverting buffers
- Output sink capability of 48 mA, source capability of 24 mA
- Output switching specified for both 50 pF and 250 pF loads

- Guaranteed simultaneous switching, noise level and dynamic threshold performance
- Guaranteed latchup protection
- High impedance glitch free bus loading during entire power up and power down cycle
- Nondestructive hot insertion capability
- Disable time less than enable time to avoid bus contention
- Standard Microcircuit Drawing (SMD) 5962-9214701

### Ordering Code

Military	Package Number	Package Description
54ABT244J-QML	J20A	20-Lead Ceramic Dual-In-Line
54ABT244W-QML	W20A	20-Lead Cerpack
54ABT244E-QML	E20A	20-Lead Ceramic Leadless Chip Carrier, Type C

### Connection Diagrams

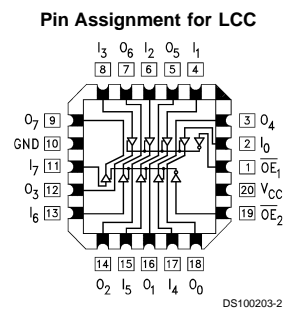
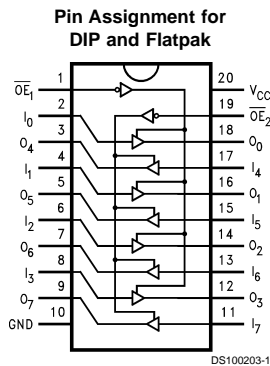

Pin Names	Description
$\overline{OE}_1, \overline{OE}_2$	Output Enable Input (Active Low)
$I_0-I_7$	Inputs
$O_0-O_7$	Outputs

### Truth Table

$\overline{OE}_1$	$I_{0-3}$	$O_{0-3}$	$\overline{OE}_2$	$I_{4-7}$	$O_{4-7}$
H	X	Z	H	X	Z
L	H	H	L	H	H
L	L	L	L	L	L

H = HIGH Voltage Level  
 L = LOW Voltage Level  
 X = Immaterial  
 Z = High Impedance

TRI-STATE® is a registered trademark of National Semiconductor Corporation.

## Absolute Maximum Ratings (Note 1)

If Military/Aerospace specified devices are required, please contact the National Semiconductor Sales Office/Distributors for availability and specifications.

Storage Temperature	-65°C to +150°C
Ambient Temperature under Bias	-55°C to +125°C
Junction Temperature under Bias	
Ceramic	-55°C to +175°C
V <sub>CC</sub> Pin Potential to Ground Pin	-0.5V to +7.0V
Input Voltage (Note 2)	-0.5V to +7.0V
Input Current (Note 2)	-30 mA to +5.0 mA
Voltage Applied to Any Output in the Disabled or Power-Off State	-0.5V to 5.5V
in the HIGH State	-0.5V to V <sub>CC</sub>

Current Applied to Output in LOW State (Max)	twice the rated I <sub>OL</sub> (mA)
DC Latchup Source Current	-500 mA
Over Voltage Latchup (I/O)	10V

## Recommended Operating Conditions

Free Air Ambient Temperature	
Military	-55°C to +125°C
Supply Voltage	
Military	+4.5V to +5.5V
Minimum Input Edge Rate	(ΔV/Δt)
Data Input	50 mV/ns
Enable Input	20 mV/ns

## DC Electrical Characteristics

Symbol	Parameter	ABT244			Units	V <sub>CC</sub>	Conditions
		Min	Typ	Max			
V <sub>IH</sub>	Input HIGH Voltage	2.0			V		Recognized HIGH Signal
V <sub>IL</sub>	Input LOW Voltage						Recognized LOW Signal
V <sub>CD</sub>	Input Clamp Diode Voltage					Min	I <sub>IN</sub> = -18 mA
V <sub>OH</sub>	Output HIGH Voltage	54ABT	2.5		V	Min	I <sub>OH</sub> = -3 mA
		54ABT	2.0		V	Min	I <sub>OH</sub> = -24 mA
V <sub>OL</sub>	Output LOW Voltage	54ABT	0.55		V	Min	I <sub>OL</sub> = 48 mA
I <sub>IH</sub>	Input HIGH Current			5	μA	Max	V <sub>IN</sub> = 2.7V (Note 4)
				5	μA	Max	V <sub>IN</sub> = V <sub>CC</sub>
I <sub>BVI</sub>	Input HIGH Current Breakdown Test			7	μA	Max	V <sub>IN</sub> = 7.0V
I <sub>IL</sub>	Input LOW Current			-5	μA	Max	V <sub>IN</sub> = 0.5V (Note 4)
				-5	μA	Max	V <sub>IN</sub> = 0.0V
V <sub>ID</sub>	Input Leakage Test	4.75			V	0.0	I <sub>ID</sub> = 1.9 μA All Other Pins Grounded
I <sub>OZH</sub>	Output Leakage Current	50			μA	0 - 5.5V	V <sub>OUT</sub> = 2.7V; $\overline{OE}_n = 2.0V$
I <sub>OZL</sub>	Output Leakage Current	-50			μA	0 - 5.5V	V <sub>OUT</sub> = 0.5V; $\overline{OE}_n = 2.0V$
I <sub>OS</sub>	Output Short-Circuit Current	-100	-275		mA	Max	V <sub>OUT</sub> = 0.0V
I <sub>CEX</sub>	Output High Leakage Current	50			μA	Max	V <sub>OUT</sub> = V <sub>CC</sub>
I <sub>ZZ</sub>	Bus Drainage Test	100			μA	0.0	V <sub>OUT</sub> = 5.5V; All Others GND
I <sub>CCH</sub>	Power Supply Current	50			μA	Max	All Outputs HIGH
I <sub>CCL</sub>	Power Supply Current	30			mA	Max	All Outputs LOW
I <sub>CCZ</sub>	Power Supply Current	50			μA	Max	$\overline{OE}_n = V_{CC}$ ; All Others at V <sub>CC</sub> or Ground
I <sub>CCT</sub>	Additional I <sub>CC</sub> /Input	Outputs Enabled	2.5		mA	Max	V <sub>I</sub> = V <sub>CC</sub> - 2.1V
		Outputs TRI-STATE	2.5		mA	Max	Enable Input V <sub>I</sub> = V <sub>CC</sub> - 2.1V
		Outputs TRI-STATE	50		μA	Max	Data Input V <sub>I</sub> = V <sub>CC</sub> - 2.1V All Others at V <sub>CC</sub> or Ground
I <sub>CCD</sub>	Dynamic I <sub>CC</sub>	No Load	0.1		mA/ MHz	Max	Outputs Open $\overline{OE}_n = GND$ , (Note 3) One Bit Toggling, 50% Duty Cycle

**Note 1:** Absolute maximum ratings are values beyond which the device may be damaged or have its useful life impaired. Functional operation under these conditions is not implied.

**Note 2:** Either voltage limit or current limit is sufficient to protect inputs.

**Note 3:** For 8 bits toggling, I<sub>CCD</sub> < 0.8 mA/MHz.

**Note 4:** Guaranteed, but not tested.

## AC Electrical Characteristics

Symbol	Parameter	54ABT		Units	Fig. No.
		$T_A = -55^\circ\text{C to } +125^\circ\text{C}$			
		$V_{CC} = 4.5\text{V} - 5.5\text{V}$			
		Min	Max		
$t_{PLH}$	Propagation Delay	1.0	5.3	ns	Figure 5
$t_{PHL}$	Data to Outputs	1.0	5.0		
$t_{PZH}$	Output Enable	0.8	6.5	ns	Figure 4
$t_{PZL}$	Time	1.2	7.9		
$t_{PHZ}$	Output Disable	1.2	7.6	ns	Figure 4
$t_{PLZ}$	Time	1.0	7.9		

## Capacitance

Symbol	Parameter	Typ	Units	Conditions $T_A = 25^\circ\text{C}$
$C_{IN}$	Input Capacitance	5.0	pF	$V_{CC} = 0\text{V}$
$C_{OUT}$ (Note 5)	Output Capacitance	9.0	pF	$V_{CC} = 5.0\text{V}$

**Note 5:**  $C_{OUT}$  is measured at frequency  $f = 1\text{ MHz}$ , per MIL-STD-883B, Method 3012.

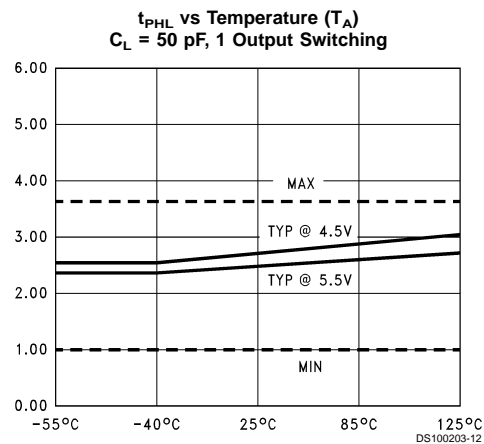
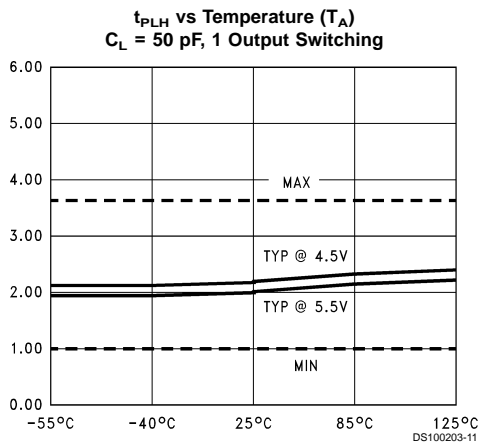

Dashed lines represent design characteristics; for specified guarantees refer to AC Characteristics Table.

## Capacitance (Continued)

**$t_{PLH}$  vs Load Capacitance**  
1 Output Switching,  $T_A = 25^\circ\text{C}$

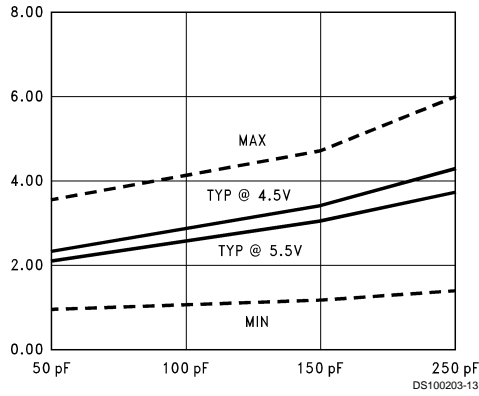

**$t_{PHL}$  vs Load Capacitance**  
1 Output Switching,  $T_A = 25^\circ\text{C}$

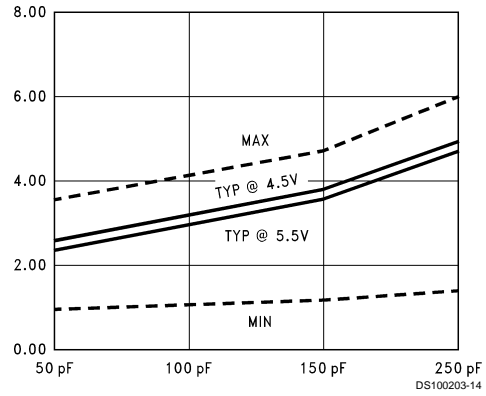

**$t_{PLH}$  vs Load Capacitance**  
8 Outputs Switching,  $T_A = 25^\circ\text{C}$

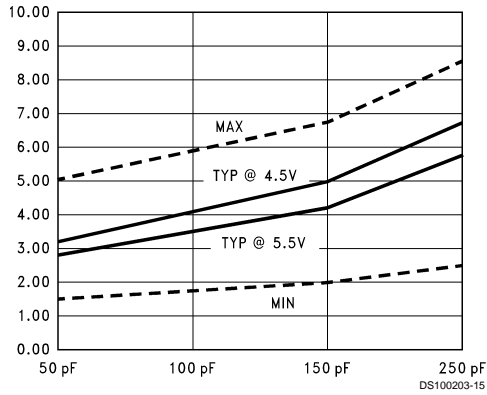

**$t_{PHL}$  vs Load Capacitance**  
8 Outputs Switching,  $T_A = 25^\circ\text{C}$

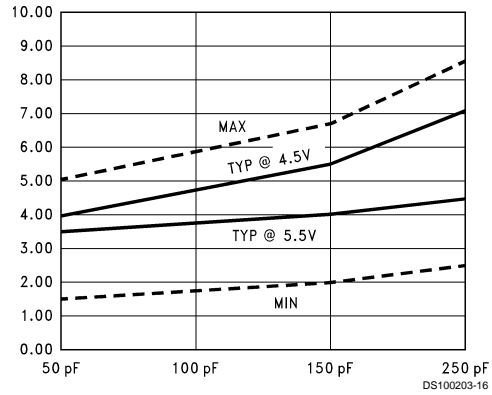

**$t_{PZL}$  vs Temperature ( $T_A$ )**  
 $C_L = 50\text{ pF}$ , 1 Output Switching

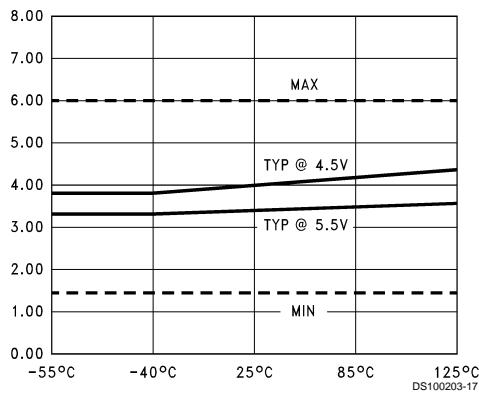

**$t_{PLZ}$  vs Temperature ( $T_A$ )**  
 $C_L = 50\text{ pF}$ , 1 Output Switching

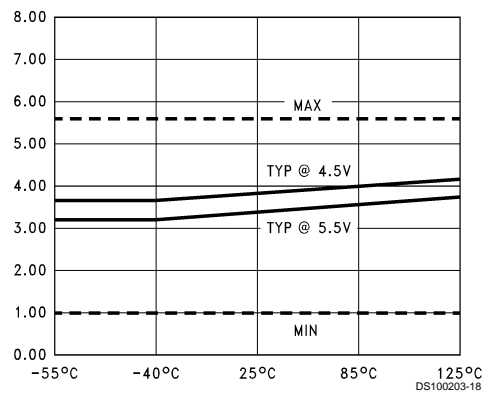

Dashed lines represent design characteristics; for specified guarantees refer to AC Characteristics Table.

## Capacitance (Continued)

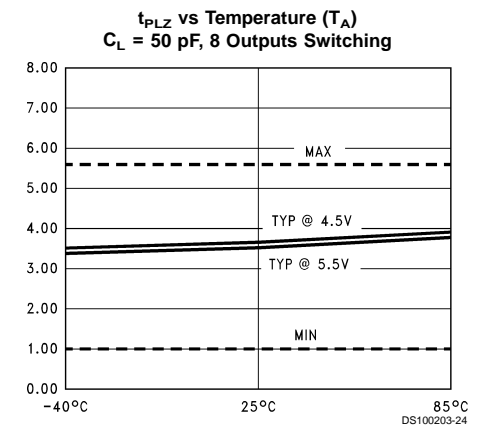
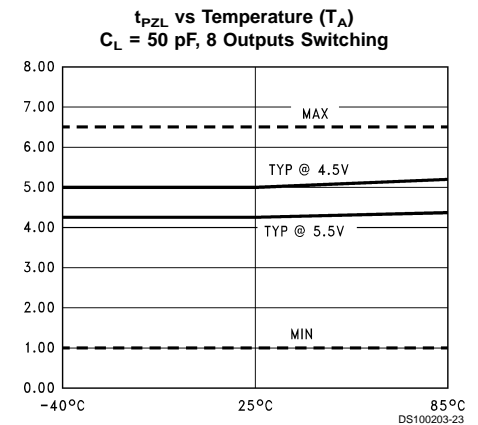
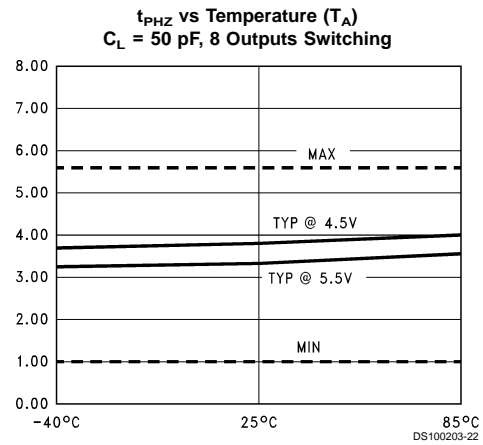
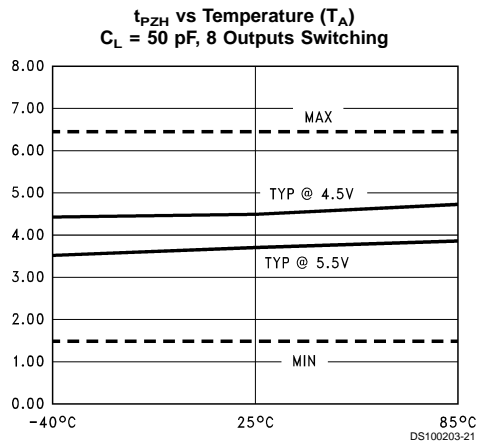
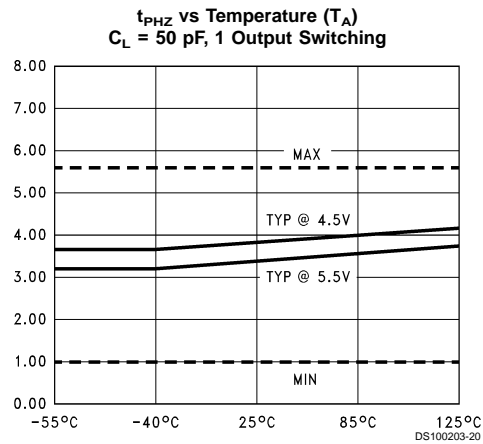
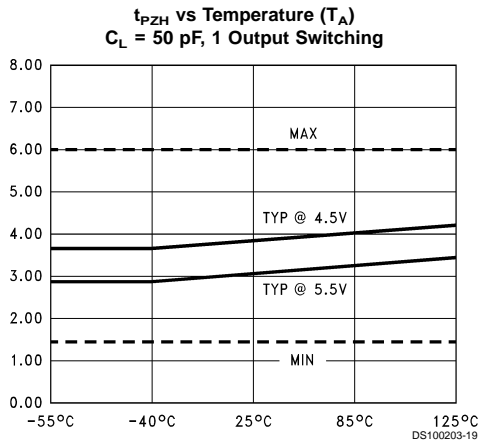

Dashed lines represent design characteristics; for specified guarantees refer to AC Characteristics Table.

## Capacitance (Continued)

**$t_{PZL}$  vs Load Capacitance**  
**8 Outputs Switching**  
 $T_A = 25^\circ\text{C}$

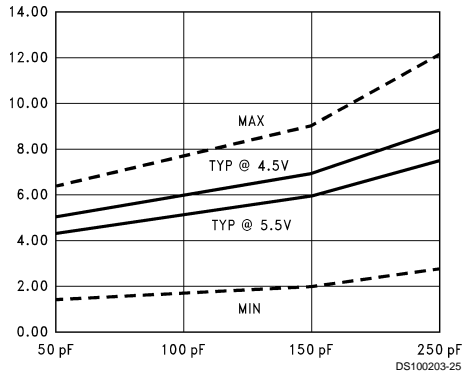

**$t_{PZH}$  vs Load Capacitance**  
**8 Outputs Switching**  
 $T_A = 25^\circ\text{C}$

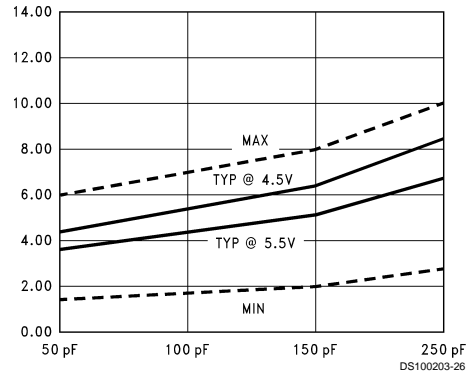

**$t_{PLH}$  and  $t_{PHL}$  vs Number**  
**Outputs Switching  $V_{CC} = 5.0\text{V}$ ,**  
 $T_A = 25^\circ\text{C}$ ,  $C_L = 50\text{ pF}$

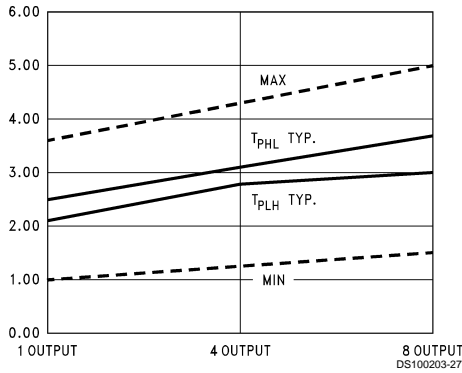

**$I_{CC}$  vs Frequency,**  
**Average,  $T_A = 25^\circ\text{C}$ ,**  
**All Outputs Unloaded/Unterminated**

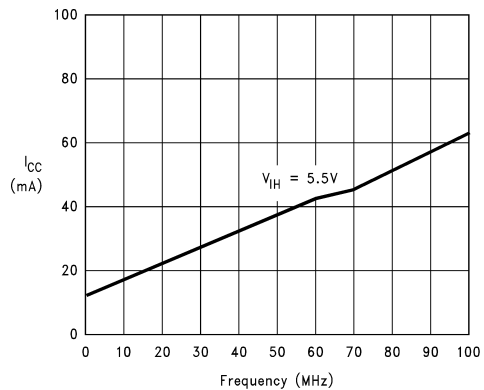

Dashed lines represent design characteristics; for specified guarantees refer to AC Characteristics Table.

## AC Loading

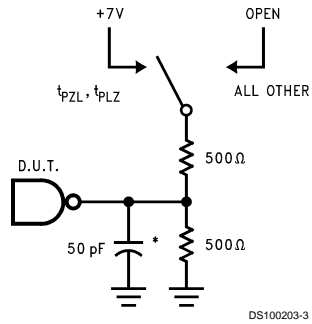

\*Includes jig and probe capacitance

**FIGURE 1. Standard AC Test Load**

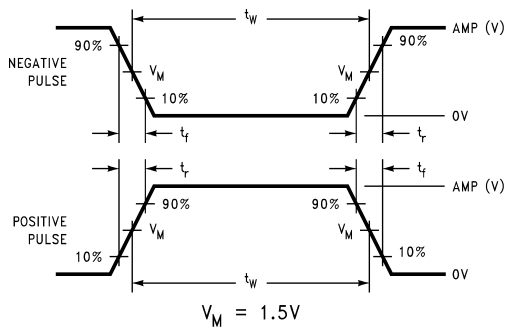
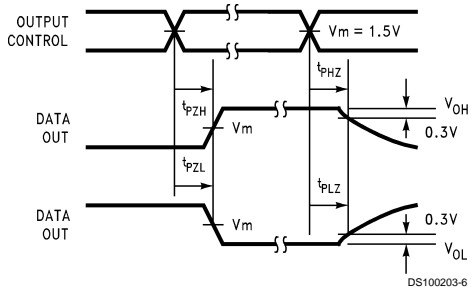

**FIGURE 2. Test Input Signal Levels**

Amplitude	Rep. Rate	$t_w$	$t_r$	$t_f$
3.0V	1 MHz	500 ns	2.5 ns	2.5 ns

**FIGURE 3. Test Input Signal Requirements**

## AC Waveforms



**FIGURE 4. TRI-STATE Output HIGH and LOW Enable and Disable Times**

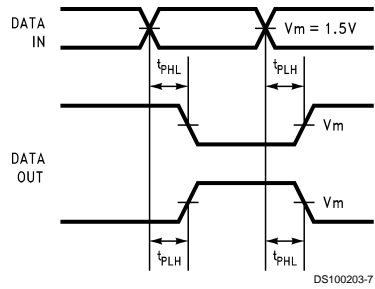
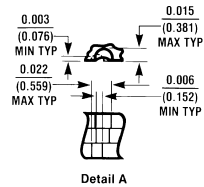
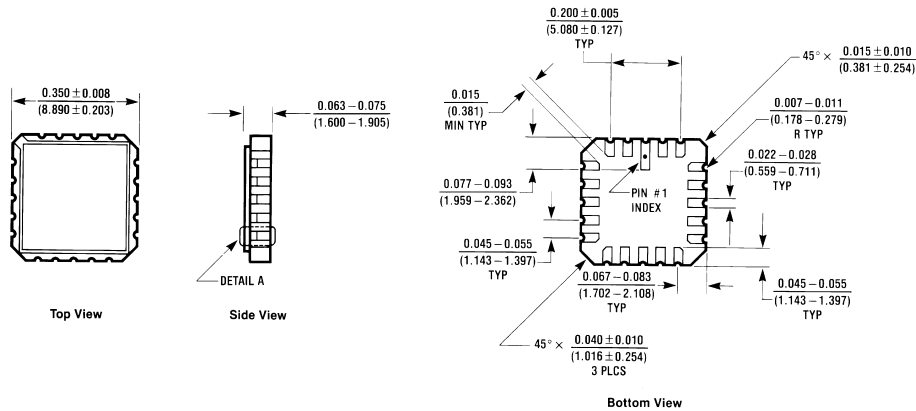

**FIGURE 5. Propagation Delay Waveforms for Inverting and Non-Inverting Functions**





**Physical Dimensions** inches (millimeters) unless otherwise noted



E20A (REV D)

**20-Terminal Ceramic Chip Carrier (L)**  
 NS Package Number E20A

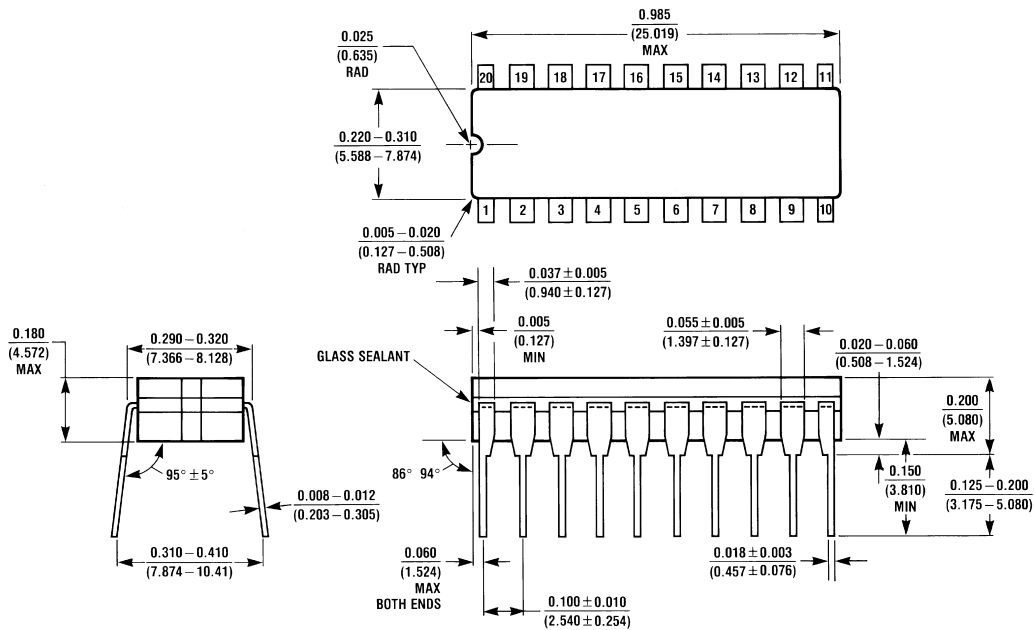

J20A (REV M)

**20-Lead Ceramic Dual-In-Line (D)**  
 NS Package Number J20A

**Physical Dimensions** inches (millimeters) unless otherwise noted (Continued)

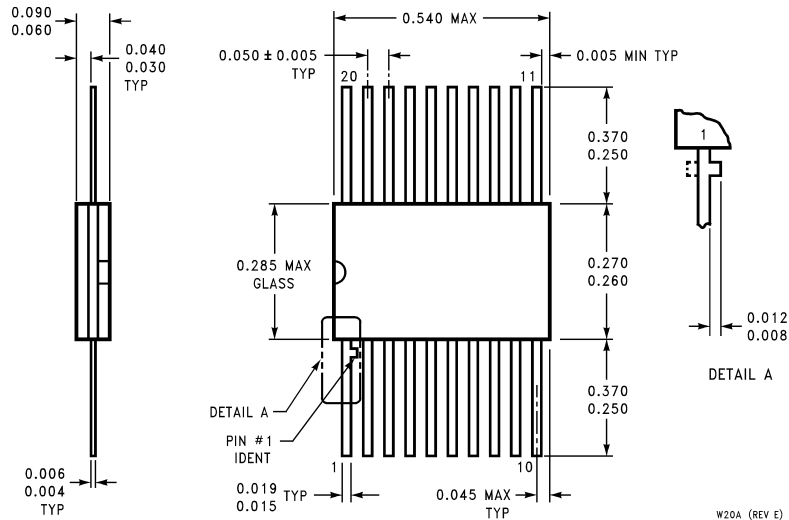

**20-Lead Ceramic Flatpak (F)  
NS Package Number W20A**

**LIFE SUPPORT POLICY**

NATIONAL'S PRODUCTS ARE NOT AUTHORIZED FOR USE AS CRITICAL COMPONENTS IN LIFE SUPPORT DEVICES OR SYSTEMS WITHOUT THE EXPRESS WRITTEN APPROVAL OF THE PRESIDENT OF NATIONAL SEMICONDUCTOR CORPORATION. As used herein:

1. Life support devices or systems are devices or systems which, (a) are intended for surgical implant into the body, or (b) support or sustain life, and whose failure to perform when properly used in accordance with instructions for use provided in the labeling, can be reasonably expected to result in a significant injury to the user.
2. A critical component in any component of a life support device or system whose failure to perform can be reasonably expected to cause the failure of the life support device or system, or to affect its safety or effectiveness.



**National Semiconductor Corporation**  
Americas  
Tel: 1-800-272-9959  
Fax: 1-800-737-7018  
Email: support@nsc.com

**National Semiconductor Europe**  
Fax: +49 (0) 1 80-530 85 86  
Email: europe.support@nsc.com  
Deutsch Tel: +49 (0) 1 80-530 85 85  
English Tel: +49 (0) 1 80-532 78 32  
Français Tel: +49 (0) 1 80-532 93 58  
Italiano Tel: +49 (0) 1 80-534 16 80

**National Semiconductor Asia Pacific Customer Response Group**  
Tel: 65-2544466  
Fax: 65-2504466  
Email: sea.support@nsc.com

**National Semiconductor Japan Ltd.**  
Tel: 81-3-5620-6175  
Fax: 81-3-5620-6179

www.national.com