

54LS85/DM54LS85/DM74LS85 4-Bit Magnitude Comparators

General Description

These 4-bit magnitude comparators perform comparison of straight binary or BCD codes. Three fully-decoded decisions about two, 4-bit words (A, B) are made and are externally available at three outputs. These devices are fully expandable to any number of bits without external gates. Words of greater length may be compared by connecting comparators in cascade. The $A > B$, $A < B$, and $A = B$ outputs of a stage handling less-significant bits are connected to the corresponding inputs of the next stage handling more-significant bits. The stage handling the least-significant bits must

have a high-level voltage applied to the $A = B$ input. The cascading path is implemented with only a two-gate-level delay to reduce overall comparison times for long words.

Features

- Typical power dissipation 52 mW
- Typical delay (4-bit words) 24 ns
- Alternate Military/Aerospace device (54LS85) is available. Contact a National Semiconductor Sales Office/Distributor for specifications.

Connection Diagram

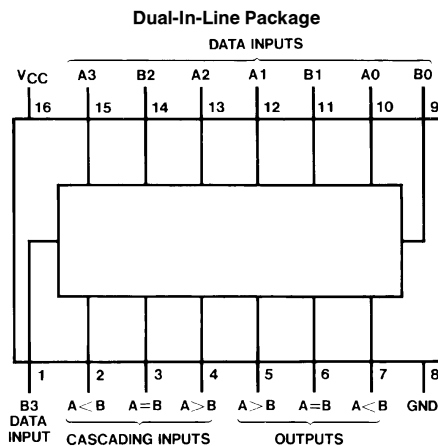

Order Number 54LS85DMQB,
54LS85FMQB, 54LS85LMQB,
DM54LS85J, DM54LS85W,
DM74LS85M or DM74LS85N
See NS Package Number E20A,
J16A, M16A, N16E or W16A

TL/F/6379-1

Function Table

Comparing Inputs				Cascading Inputs			Outputs		
A3, B3	A2, B2	A1, B1	A0, B0	A > B	A < B	A = B	A > B	A < B	A = B
A3 > B3	X	X	X	X	X	X	H	L	L
A3 < B3	X	X	X	X	X	X	L	H	L
A3 = B3	A2 > B2	X	X	X	X	X	H	L	L
A3 = B3	A2 < B2	X	X	X	X	X	L	H	L
A3 = B3	A2 = B2	A1 > B1	X	X	X	X	H	L	L
A3 = B3	A2 = B2	A1 < B1	X	X	X	X	L	H	L
A3 = B3	A2 = B2	A1 = B1	A0 > B0	X	X	X	H	L	L
A3 = B3	A2 = B2	A1 = B1	A0 < B0	X	X	X	L	H	L
A3 = B3	A2 = B2	A1 = B1	A0 = B0	H	L	L	H	L	L
A3 = B3	A2 = B2	A1 = B1	A0 = B0	L	H	L	L	H	L
A3 = B3	A2 = B2	A1 = B1	A0 = B0	L	L	H	L	L	H
A3 = B3	A2 = B2	A1 = B1	A0 = B0	X	X	H	L	L	H
A3 = B3	A2 = B2	A1 = B1	A0 = B0	H	H	L	L	L	L
A3 = B3	A2 = B2	A1 = B1	A0 = B0	L	L	L	H	H	L

H = High Level, L = Low Level, X = Don't Care

Absolute Maximum Ratings (Note)

If Military/Aerospace specified devices are required, please contact the National Semiconductor Sales Office/Distributors for availability and specifications.

Supply Voltage	7V
Input Voltage	7V
Operating Free Air Temperature Range	
DM54LS and 54LS	−55°C to +125°C
DM74LS	0°C to +70°C
Storage Temperature Range	−65°C to +150°C

Note: The "Absolute Maximum Ratings" are those values beyond which the safety of the device cannot be guaranteed. The device should not be operated at these limits. The parametric values defined in the "Electrical Characteristics" table are not guaranteed at the absolute maximum ratings. The "Recommended Operating Conditions" table will define the conditions for actual device operation.

Recommended Operating Conditions

Symbol	Parameter	DM54LS85			DM74LS85			Units
		Min	Nom	Max	Min	Nom	Max	
V _{CC}	Supply Voltage	4.5	5	5.5	4.75	5	5.25	V
V _{IH}	High Level Input Voltage	2			2			V
V _{IL}	Low Level Input Voltage			0.7			0.8	V
I _{OH}	High Level Output Current			−0.4			−0.4	mA
I _{OL}	Low Level Output Current			4			8	mA
T _A	Free Air Operating Temperature	−55		125	0		70	°C

Electrical Characteristics over recommended operating free air temperature range (unless otherwise noted)

Symbol	Parameter	Conditions	Min	Typ (Note 1)	Max	Units
V _I	Input Clamp Voltage	V _{CC} = Min, I _I = −18 mA			−1.5	V
V _{OH}	High Level Output Voltage	V _{CC} = Min, I _{OH} = Max V _{IL} = Max, V _{IH} = Min	DM54 2.5	3.4		V
V _{OL}	Low Level Output Voltage	V _{CC} = Min, I _{OL} = Max V _{IL} = Max, V _{IH} = Min	DM54	0.25	0.4	V
		I _{OL} = 4 mA, V _{CC} = Min	DM74	0.35	0.5	
I _I	Input Current @ Max Input Voltage	V _{CC} = Max V _I = 7V	A < B		0.1	mA
			A > B		0.1	
			Others		0.3	
I _{IH}	High Level Input Current	V _{CC} = Max V _I = 2.7V	A < B		20	μA
			A > B		20	
			Others		60	
I _{IL}	Low Level Input Current	V _{CC} = Max V _I = 0.4V	A < B		−0.4	mA
			A > B		−0.4	
			Others		−1.2	
I _{OS}	Short Circuit Output Current	V _{CC} = Max (Note 2)	DM54	−20	−100	mA
			DM74	−20	−100	
I _{CC}	Supply Current	V _{CC} = Max (Note 3)		10	20	mA

Note 1: All typicals are at V_{CC} = 5V, T_A = 25°C.

Note 2: Not more than one output should be shorted at a time, and the duration should not exceed one second.

Note 3: I_{CC} is measured with all outputs open, A = B grounded and all other inputs at 4.5V.

Switching Characteristics at $V_{CC} = 5V$ and $T_A = 25^\circ C$ (See Section 1 for Test Waveforms and Output Load)

Symbol	Parameter	From Input	To Output	Number of Gate Levels	$R_L = 2\text{ k}\Omega$				Units
					$C_L = 15\text{ pF}$		$C_L = 50\text{ pF}$		
					Min	Max	Min	Max	
t_{PLH}	Propagation Delay Time Low-to-High Level Output	Any A or B Data Input	A < B, A > B	3		36		42	ns
			A = B	4		40		40	
t_{PHL}	Propagation Delay Time High-to-Low Level Output	Any A or B Data Input	A < B, A > B	3		30		40	ns
			A = B	4		30		40	
t_{PLH}	Propagation Delay Time Low-to-High Level Output	A < B or A = B	A > B	1		22		26	ns
t_{PHL}	Propagation Delay Time High-to-Low Level Output	A < B or A = B	A > B	1		17		26	ns
t_{PLH}	Propagation Delay Time Low-to-High Level Output	A = B	A = B	2		20		25	ns
t_{PHL}	Propagation Delay Time High-to-Low Level Output	A = B	A = B	2		17		26	ns
t_{PLH}	Propagation Delay Time Low-to-High Level Output	A > B or A = B	A < B	1		22		26	ns
t_{PHL}	Propagation Delay Time High-to-Low Level Output	A > B or A = B	A < B	1		17		26	ns

Logic Diagram

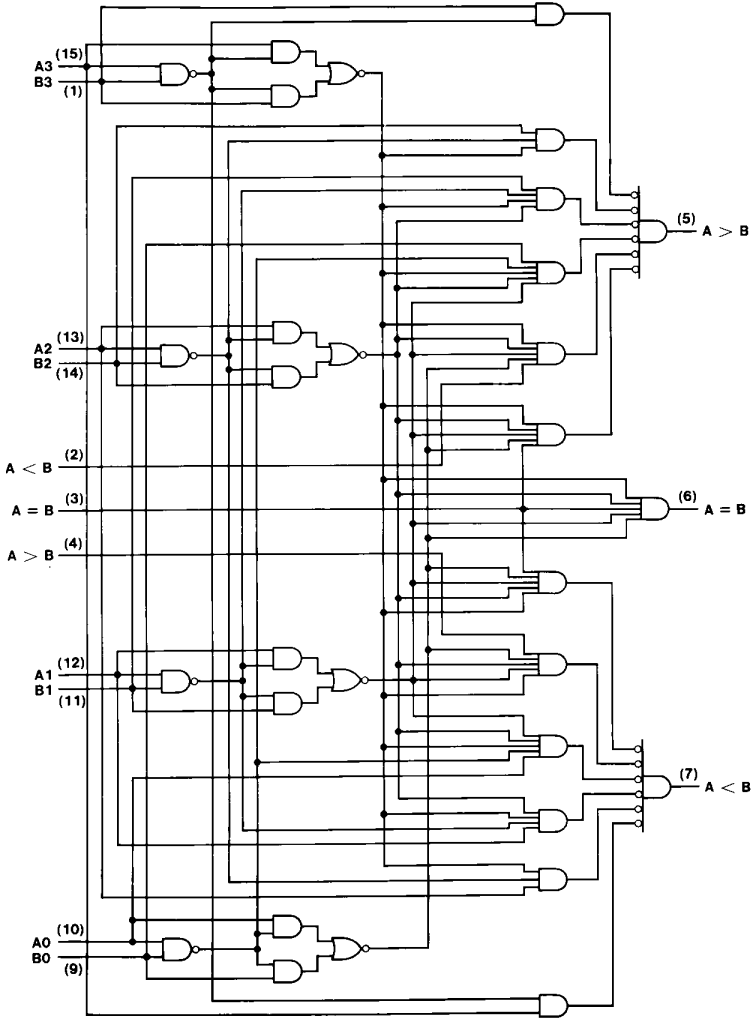

TL/F/6379-2



Physical Dimensions inches (millimeters)

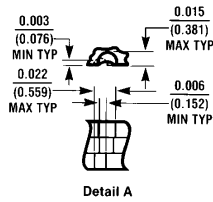
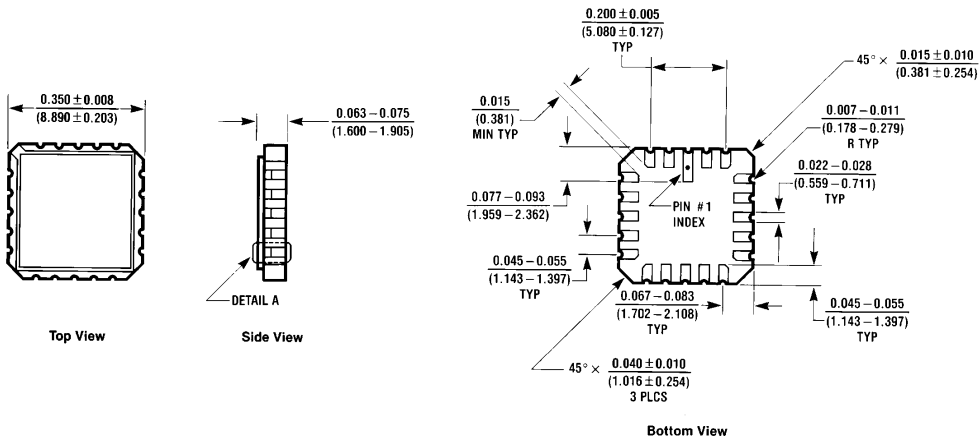

Chip Carrier Package (E)
Order Number 54LS85MQB
NS Package Number E20A

E20A (REV D)

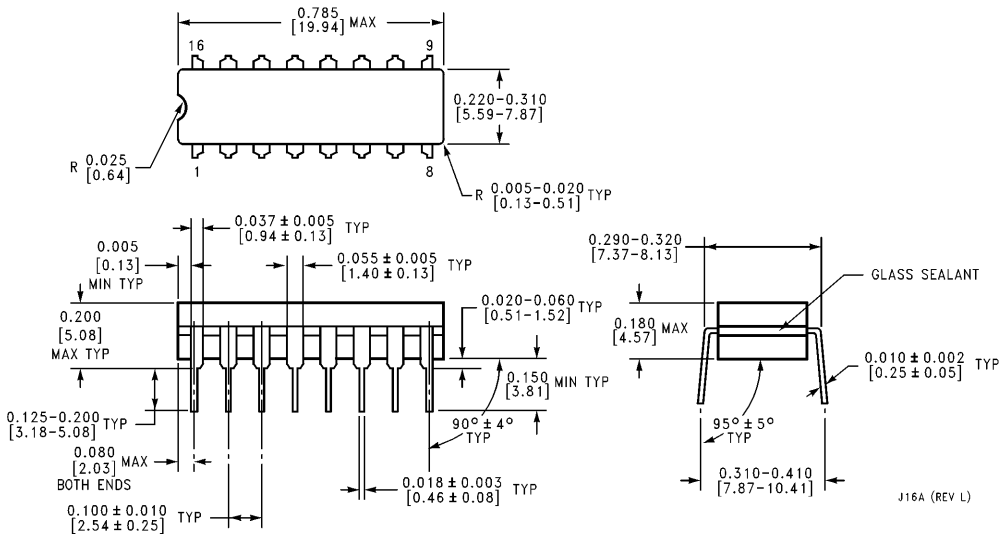

16-Lead Ceramic Dual-In-Line Package (J)
Order Number 54LS85DMQB or DM54LS85J
NS Package Number J16A

J16A (REV L)

Physical Dimensions inches (millimeters) (Continued)

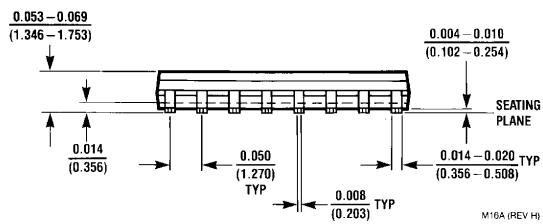
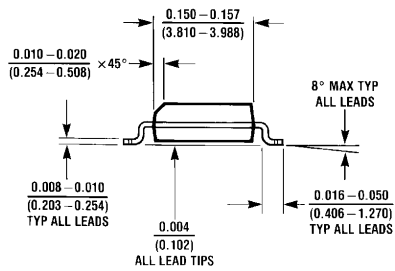
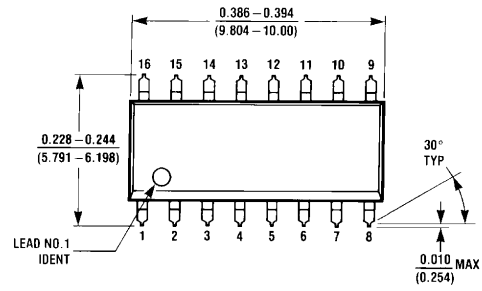

M16A (REV H)

16-Lead Small Outline Molded Package (M)
Order Number DM74LS85M
NS Package Number M16A

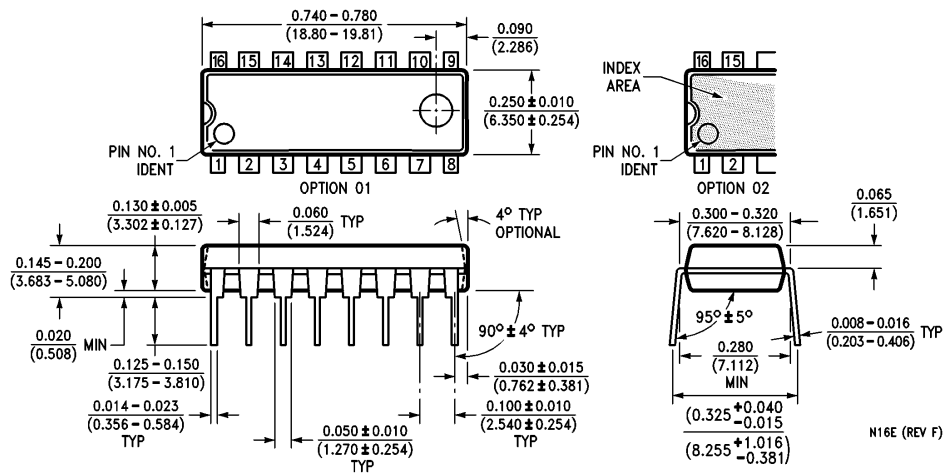

N16E (REV F)

16-Lead Molded Dual-In-Line Package (N)
Order Number DM74LS85N
NS Package Number N16E

Physical Dimensions inches (millimeters) (Continued)

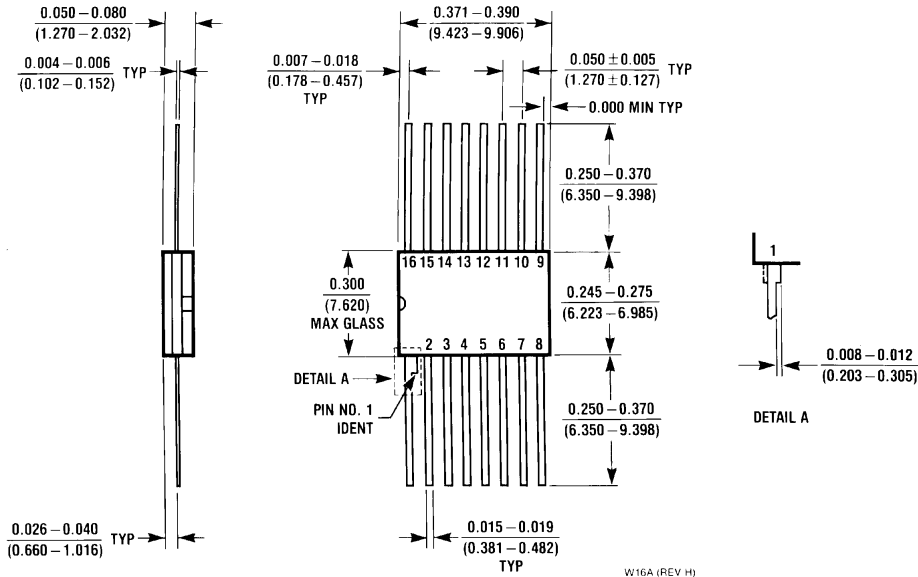

16-Lead Ceramic Flat Package (W)
Order Number 54LS85FMQB or DM54LS85W
NS Package Number W16A

LIFE SUPPORT POLICY

NATIONAL'S PRODUCTS ARE NOT AUTHORIZED FOR USE AS CRITICAL COMPONENTS IN LIFE SUPPORT DEVICES OR SYSTEMS WITHOUT THE EXPRESS WRITTEN APPROVAL OF THE PRESIDENT OF NATIONAL SEMICONDUCTOR CORPORATION. As used herein:

1. Life support devices or systems are devices or systems which, (a) are intended for surgical implant into the body, or (b) support or sustain life, and whose failure to perform, when properly used in accordance with instructions for use provided in the labeling, can be reasonably expected to result in a significant injury to the user.
2. A critical component is any component of a life support device or system whose failure to perform can be reasonably expected to cause the failure of the life support device or system, or to affect its safety or effectiveness.



National Semiconductor Corporation
 1111 West Bardin Road
 Arlington, TX 76017
 Tel: 1(800) 272-9959
 Fax: 1(800) 737-7018

National Semiconductor Europe
 Fax: (+49) 0-180-530 85 86
 Email: cnjwge@tevm2.nsc.com
 Deutsch Tel: (+49) 0-180-530 85 85
 English Tel: (+49) 0-180-532 78 32
 Français Tel: (+49) 0-180-532 93 58
 Italiano Tel: (+49) 0-180-534 16 80

National Semiconductor Hong Kong Ltd.
 13th Floor, Straight Block,
 Ocean Centre, 5 Canton Rd.
 Tsimshatsui, Kowloon
 Hong Kong
 Tel: (852) 2737-1600
 Fax: (852) 2736-9960

National Semiconductor Japan Ltd.
 Tel: 81-043-299-2309
 Fax: 81-043-299-2408

National does not assume any responsibility for use of any circuitry described, no circuit patent licenses are implied and National reserves the right at any time without notice to change said circuitry and specifications.