



POSEICO SPA  
POwer SEmiconductors Italian COrporation

POSEICO SPA  
Via N. Lorenzi 8, 16152 Genova - ITALY  
Tel. ++ 39 010 6556234 - Fax ++ 39 010 6557519  
Sales Office:  
Tel. ++ 39 010 6556775 - Fax ++ 39 010 6442510

**RECTIFIER DIODE**

**AR709**

Repetitive voltage up to **1000 V**  
Mean forward current **8710 A**  
Surge current **85 kA**

**FINAL SPECIFICATION**  
set 02 - ISSUE : 03

Symbol	Characteristic	Conditions	Tj [°C]	Value	Unit
<b>BLOCKING</b>					
V <sub>RRM</sub>	Repetitive peak reverse voltage		190	1000	V
V <sub>RSM</sub>	Non-repetitive peak reverse voltage		190	1100	V
I <sub>RRM</sub>	Repetitive peak reverse current	V=VRRM	190	200	mA
<b>CONDUCTING</b>					
I <sub>F(AV)</sub>	Mean forward current	180° sin ,50 Hz, Th=55°C, double side cooled		8710	A
I <sub>F(AV)</sub>	Mean forward current	180° sin ,50 Hz, Tc=85°C, double side cooled		8420	A
I <sub>FSM</sub>	Surge forward current	Sine wave, 10 ms without reverse voltage	190	85	kA
I <sup>2</sup> t	I <sup>2</sup> t			36125 x 1E3	A <sup>2</sup> s
V <sub>FM</sub>	Forward voltage	Forward current = 6000 A	25	1.14	V
V <sub>F(TO)</sub>	Threshold voltage		190	0.70	V
r <sub>F</sub>	Forward slope resistance		190	0.033	mohm
<b>SWITCHING</b>					
t <sub>rr</sub>	Reverse recovery time				µs
Q <sub>rr</sub>	Reverse recovery charge		190		µC
I <sub>rr</sub>	Peak reverse recovery current				A
<b>MOUNTING</b>					
R <sub>th(j-h)</sub>	Thermal impedance, DC	Junction to heatsink, double side cooled		11	°C/kW
R <sub>th(c-h)</sub>	Thermal impedance	Case to heatsink, double side cooled		2	°C/kW
T <sub>j</sub>	Operating junction temperature			-30 / 190	°C
F	Mounting force			46.0 / 54.0	kN
	Mass			1700	g

**ORDERING INFORMATION : AR709 S 10**  
standard specification   VRRM/100

## DISSIPATION CHARACTERISTICS

SQUARE WAVE

Th [°C]

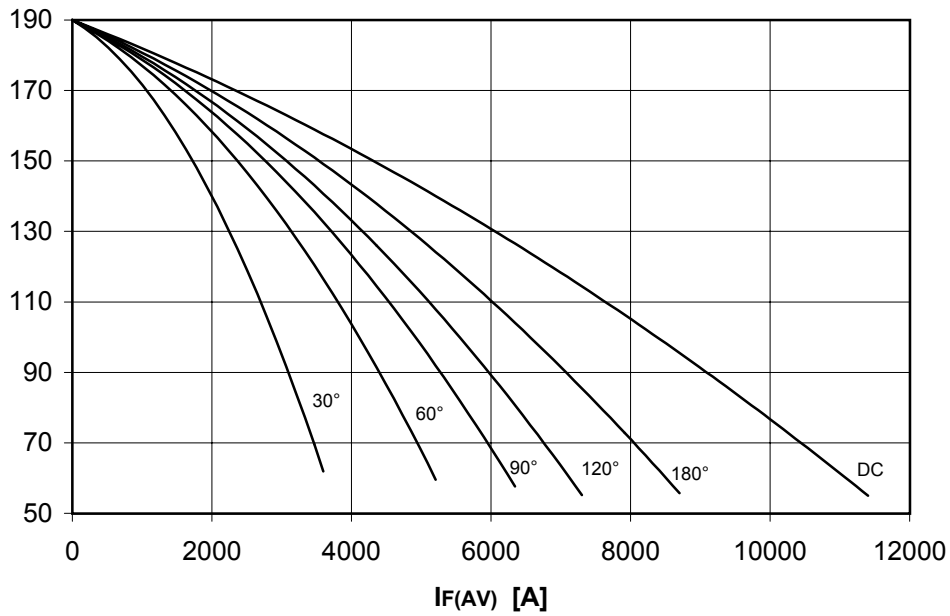

PF(AV) [W]

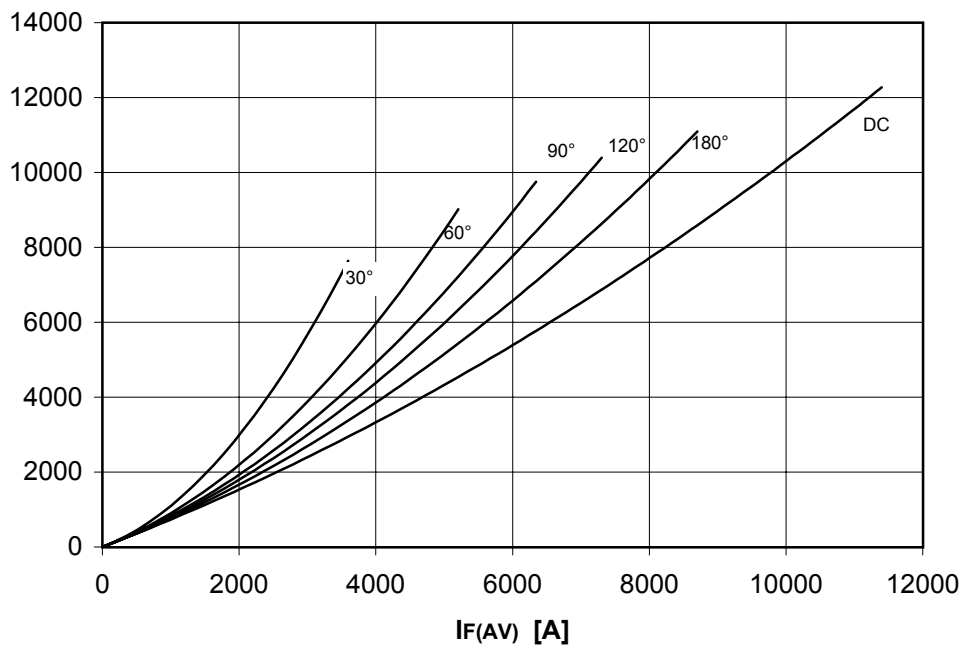

## DISSIPATION CHARACTERISTICS

SINE WAVE

Th [°C]

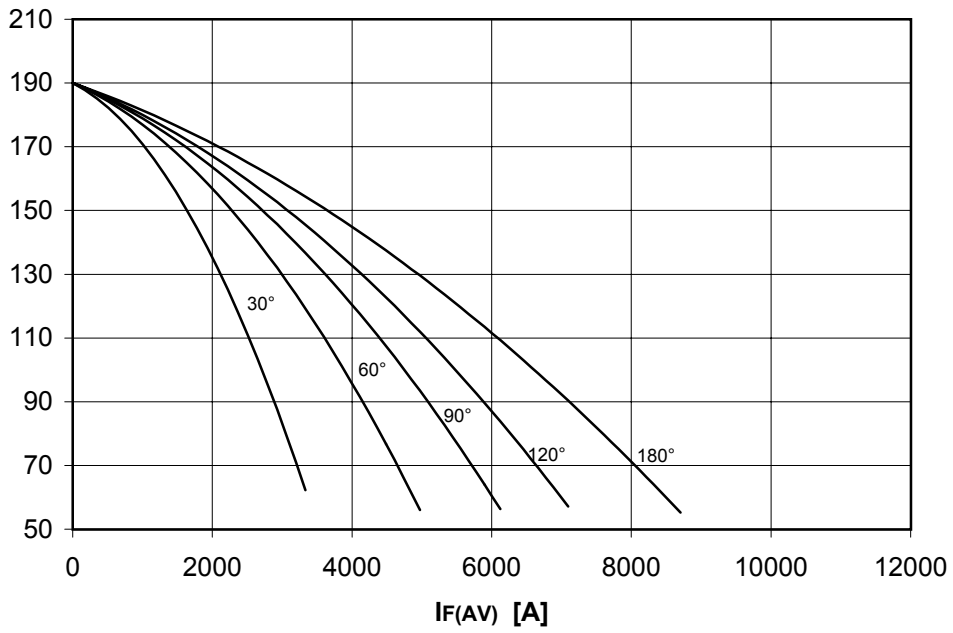

PF(AV) [W]

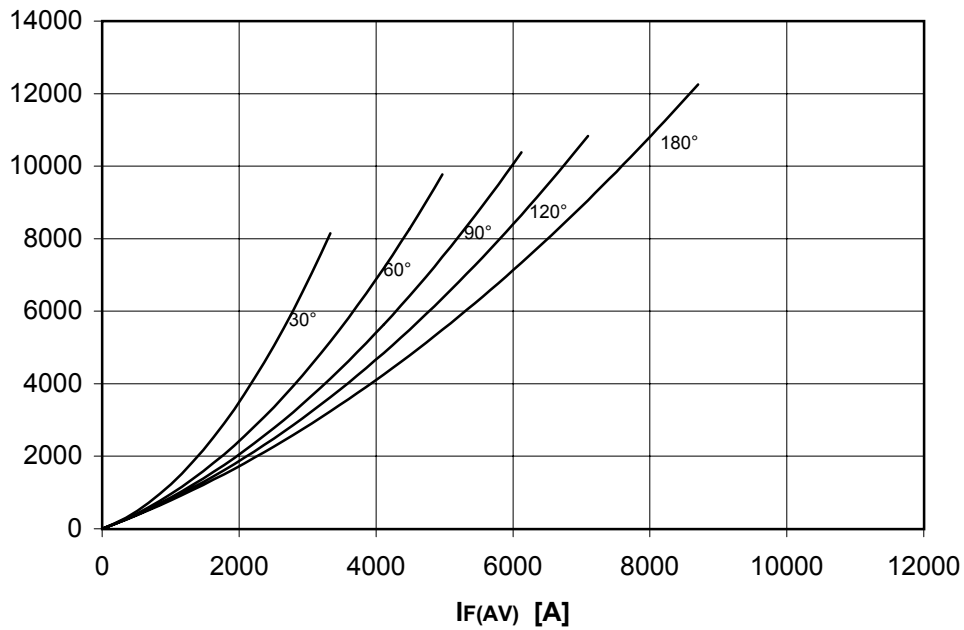

# AR709 RECTIFIER DIODE

FINAL SPECIFICATION set 02 - ISSUE : 03

FORWARD CHARACTERISTIC  
 $T_j = 190\text{ }^\circ\text{C}$

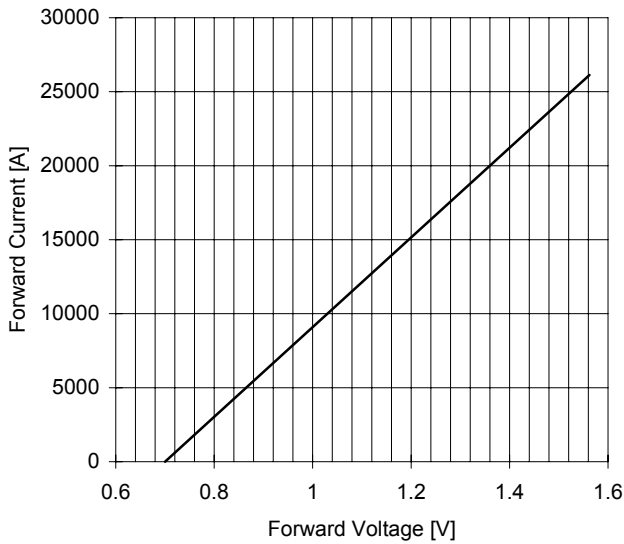

SURGE CHARACTERISTIC  
 $T_j = 190\text{ }^\circ\text{C}$

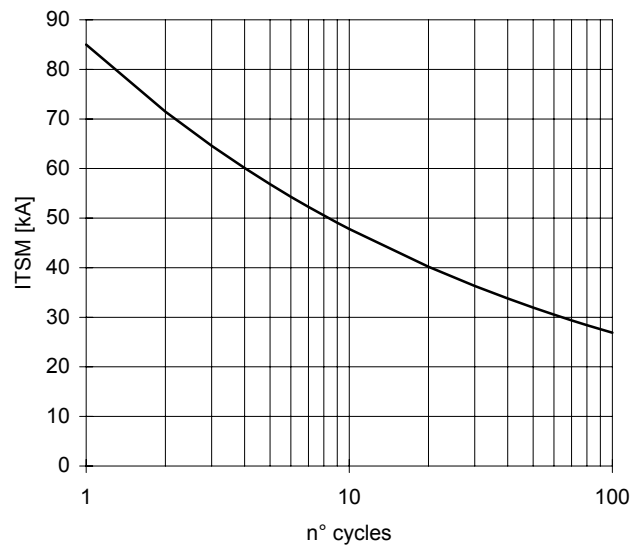

TRANSIENT THERMAL IMPEDANCE  
 DOUBLE SIDE COOLED

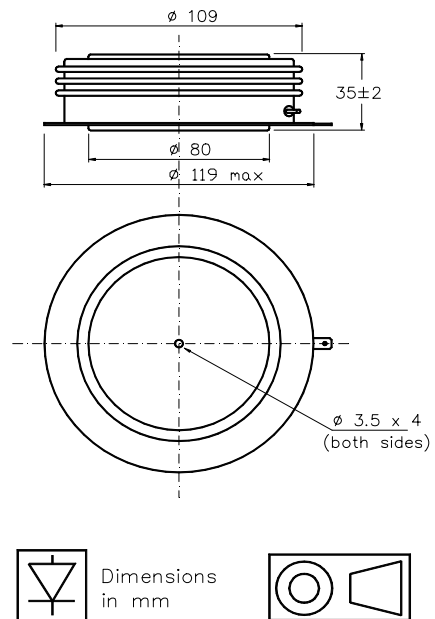
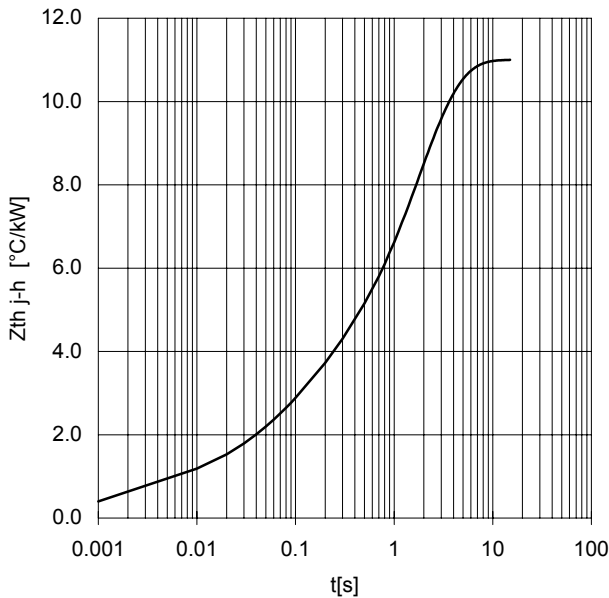

All the characteristics given in this data sheet are guaranteed only with uniform clamping force, cleaned and lubricated heatsink, surfaces with flatness < .03 mm and roughness < 2  $\mu\text{m}$ .  
 In the interest of product improvement POSEICO SPA reserves the right to change any data given in this data sheet at any time without previous notice.  
 If not stated otherwise the maximum value of ratings (symbols over shaded background) and characteristics is reported.

Distributed by

