

Powerex, Inc., Hillis Street, Youngwood, Pennsylvania 15697 (724) 925-7272

POW-R-BLOK™
AC Switch SCR Isolated Module
1550 Amps RMS, Up to 1800 Volts

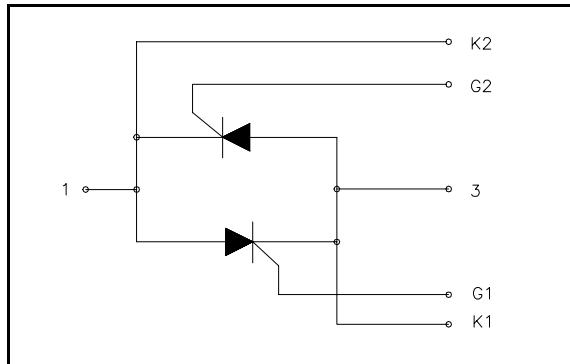

Ordering Information:

Select the complete eight-digit module part number from the table below.

Example: PA431807 is a 1800 Volt, 700A Average/SCR (1550 Ampere RMS/Switch) SCR AC Switch Isolated POW-R-BLOK™ Module

Type	Voltage Volts (x100)	Current Amperes (x100)
PA43	12	07
	14	Average
	16	Current
	18	Per SCR

Description:

Powerex AC Switch SCR Modules are designed for use in applications requiring phase control and isolated packaging. The modules are isolated for easy mounting with other components on a common heatsink.

Features:

- Electrically Isolated Heatsinking
- Compression Bonded Elements
- Metal Baseplate
- Low Thermal Impedance for Improved Current Capability

Benefits:

- No Additional Insulation Components Required
- Easy Installation
- No Clamping Components Required
- Reduce Engineering Time

Applications:

- Transfer Switches
- AC Welders
- Motor Soft Starters

Powerex, Inc., Hillis Street, Youngwood, Pennsylvania 15697 (724) 925-7272

POW-R-BLOK™
AC Switch SCR Isolated Module
1550 Amps RMS, Up to 1800 Volts

Absolute Maximum Ratings

Characteristics	Conditions	Symbol		Units
Repetitive Peak Forward and Reverse Blocking Voltage		V_{DRM} & V_{RRM}	1800	V
Non-Repetitive Peak Blocking Voltage ($t < 5$ msec)		V_{RSM}	1900	V
RMS Current	180° Conduction, $T_C=74^\circ\text{C}$	$I_{T(RMS)}$	1775	A
(AC Switch, 180° Conduction)	180° Conduction, $T_C=78^\circ\text{C}$	$I_{T(RMS)}$	1665	A
	180° Conduction, $T_C=82^\circ\text{C}$	$I_{T(RMS)}$	1550	A
	180° Conduction, $T_C=86^\circ\text{C}$	$I_{T(RMS)}$	1440	A
Average Forward Current Per SCR (180° Conduction)	180° Conduction, $T_C=74^\circ\text{C}$	$I_{T(AV)}$	800	A
	180° Conduction, $T_C=78^\circ\text{C}$	$I_{T(AV)}$	750	A
	180° Conduction, $T_C=82^\circ\text{C}$	$I_{T(AV)}$	700	A
	180° Conduction, $T_C=86^\circ\text{C}$	$I_{T(AV)}$	650	A
Peak One Cycle Surge Current, Non-Repetitive $T_j = 25\text{C}$, $V_r = 0$	60 Hz	I_{TSM}	69,000	A
	50 Hz	I_{TSM}	63,000	A
Peak One Cycle Surge Current, Non-Repetitive $T_j = 25\text{C}$, $V_r = V_{rrm}$	60 Hz	I_{TSM}	46,000	A
	50 Hz	I_{TSM}	42,000	A
Peak One Cycle Surge Current, Non-Repetitive $T_j = 125\text{C}$, $V_r = 0$	60 Hz	I_{TSM}	60,000	A
	50 Hz	I_{TSM}	54,750	A
Peak One Cycle Surge Current, Non-Repetitive $T_j = 125\text{C}$, $V_r = V_{rrm}$	60 Hz	I_{TSM}	40,000	A
	50 Hz	I_{TSM}	36,500	A
Peak Three Cycle Surge Current, Non-Repetitive	60 Hz, $T_j = 125\text{C}$, $V_r = V_{rrm}$	I_{TSM}	32,100	A
Peak Ten Cycle Surge Current, Non-Repetitive	60 Hz, $T_j = 125\text{C}$, $V_r = V_{rrm}$	I_{TSM}	25,200	A
I^2t for Fusing for One Cycle $T_j = 125\text{C}$, $V_r = V_{rrm}$	8.3 milliseconds	I^2t	6.60×10^6	$\text{A}^2 \text{sec}$
	10 milliseconds	I^2t	6.66×10^6	$\text{A}^2 \text{sec}$
Maximum Rate-of-Rise of On-State Current, (Non-Repetitive)	Per JEDEC Standard 397 5.2.2.6	di/dt	400	$\text{A}/\mu\text{s}$
Maximum Rate-of-Rise of On-State Current, (Repetitive)	Per JEDEC Standard 397 5.2.2.6	di/dt	150	$\text{A}/\mu\text{s}$
Operating Temperature		T_j	-40 to +125	$^\circ\text{C}$
Storage Temperature		T_{stg}	-40 to +150	$^\circ\text{C}$
Max. Mounting Torque, M6 Mounting Screw			132	in. – Lb.
			15	Nm
Max. Mounting Torque, M10 Terminal Screw			106	in. – Lb.
			12	Nm
Module Weight, Typical			455	g
			11.75	lb
V Isolation @ 25C		V_{rms}	3000	V

Powerex, Inc., Hillis Street, Youngwood, Pennsylvania 15697 (724) 925-7272

POW-R-BLOK™
AC Switch SCR Isolated Module
1550 Amps RMS, Up to 1800 Volts

Electrical Characteristics, T_J=25° C unless otherwise specified

Characteristics	Symbol	Test Conditions	Min.	Max.	Units
Repetitive Peak Forward Leakage Current	I _{DRM}	Up to 1800V, T _J =125° C		100	mA
Repetitive Peak Reverse Leakage Current	I _{RRM}	Up to 1800V, T _J =125° C		100	mA
Peak On-State Voltage	V _{FM}	I _{TM} =3000A, T _J =125° C		1.30	V
Threshold Voltage, Low-level	V _{(TO)1}	T _J = 125° C, I = 15%I _{T(AV)} to πI _{T(AV)}		0.703	V
Slope Resistance, Low-level	r _{T1}			0.184	mΩ
Threshold Voltage, High-level	V _{(TO)2}	T _J = 125° C, I = πI _{T(AV)} to I _{TSM}		1.01	V
Slope Resistance, High-level	r _{T2}			0.117	mΩ
V _{TM} Coefficients, Full Range		T _J = 125° C, I = 50A to 6kA V _{TM} = A + B Ln I + C I + D Sqrt I	A = B = C = D =	0.7999 -4.62 E-02 7.33 E-05 1.10 E-02	
Minimum dV/dt	dV/dt	Exponential to 0.67V _{DRM} T _J =125° C, Gate Open	600 Typ.		V/μs
Gate Trigger Current	I _{GT}	T _J =25° C, V _D =12V		200	mA
Gate Trigger Voltage	V _{GT}	T _J =25° C, V _D =12V		3.0	Volts
Non-Triggering Gate Voltage	V _{GDM}	T _J =125° C, V _D = ½ V _{DRM}		0.15	Volts
Holding Current	I _H			300	mA
Peak Forward Gate Current	I _{GTM}			4.0	Amp
Peak Reverse Gate Voltage	V _{GDM}			5	Volts
Maximum Average Gate Power Dissipation	P _{GM(AVE)}			16	Watts

Thermal Characteristics

Characteristics	Symbol		Max.	Units
Thermal Resistance, Junction to Case	R _{ΘJ-C}	Per Module, both conducting Per Junction, both conducting	0.029 0.058	°C/W °C/W
Thermal Impedance Coefficients	Z _{ΘJ-C}	Z _{ΘJ-C} = K ₁ (1-exp(-t/τ ₁)) + K ₂ (1-exp(-t/τ ₂)) + K ₃ (1-exp(-t/τ ₃)) + K ₄ (1-exp(-t/τ ₄))	K ₁ = 5.04 E-04 K ₂ = 2.31 E-03 K ₃ = 2.83 E-03 K ₄ = 5.24 E-02	τ ₁ = 2.47 E-03 τ ₂ = 4.42 E-02 τ ₃ = 1.370 τ ₄ = 9.668
Thermal Resistance, Case to Sink Lubricated	R _{ΘC-S}	Per Module	0.009	°C/W

Powerex, Inc., Hillis Street, Youngwood, Pennsylvania 15697 (724) 925-7272

AC Switch SCR Module 1530 Amps RMS, Up to 1800 Volts

Typical On-State Forward Voltage Drop
($T_J = 125^\circ\text{C}$)

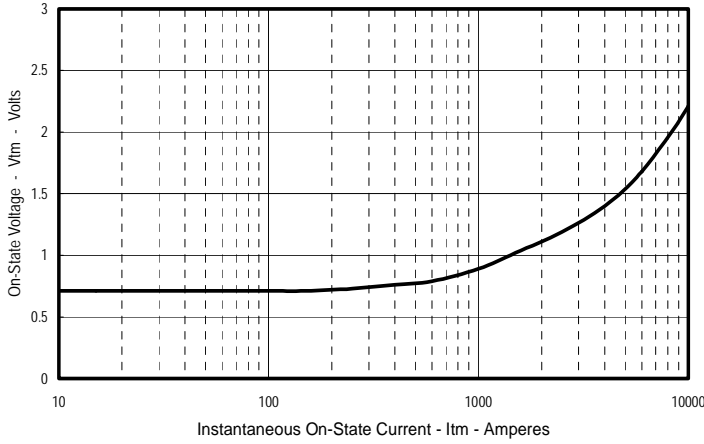

Maximum Transient Thermal Impedance
(Junction To Case)

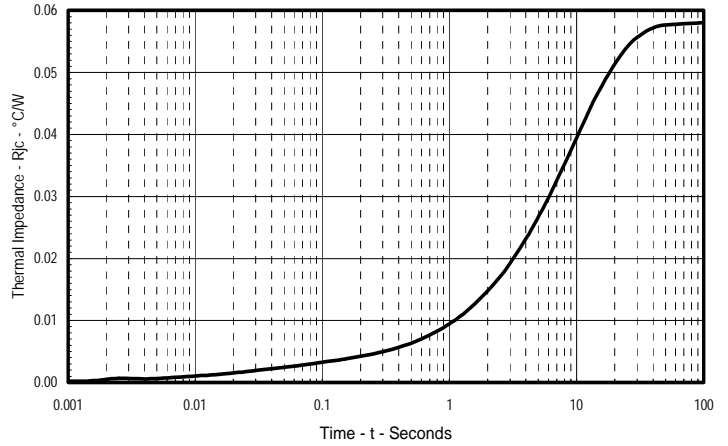

Maximum On-State Power Dissipation
(Sinusoidal Waveform)

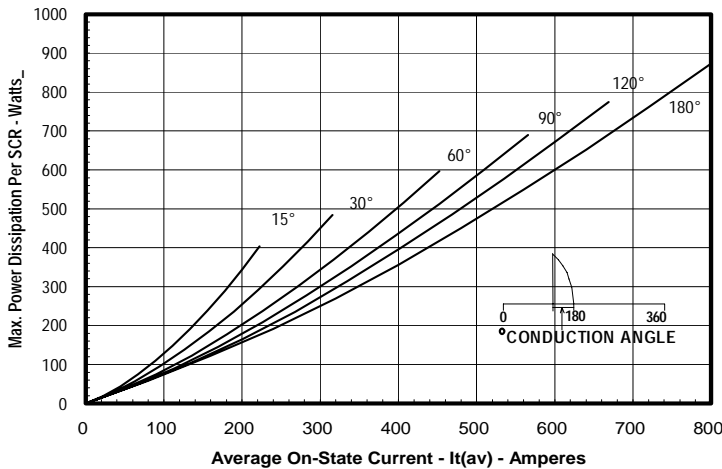

Maximum Allowable Case Temperature
(Sinusoidal Waveform)

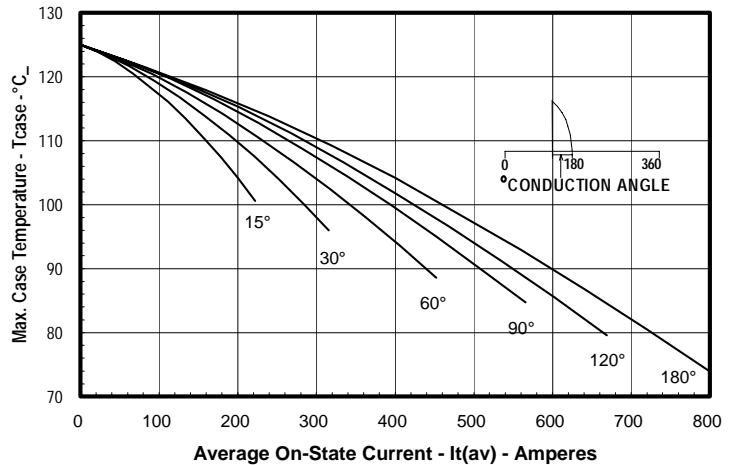

Maximum On-State Power Dissipation
(Rectangular Waveform)

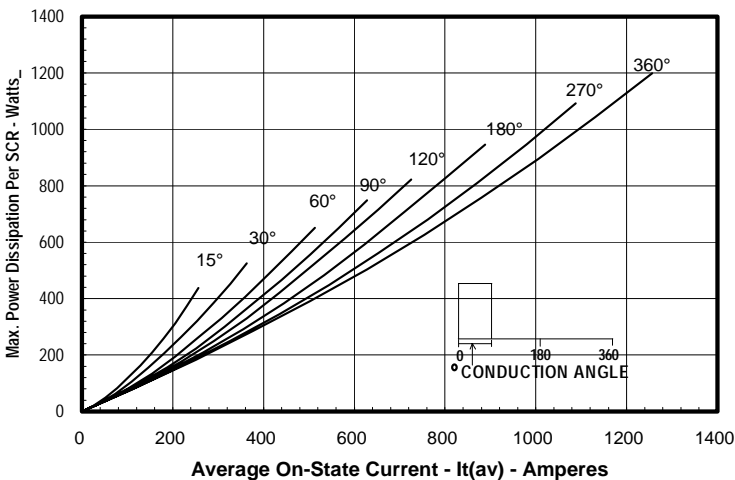

Maximum Allowable Case Temperature
(Rectangular Waveform)

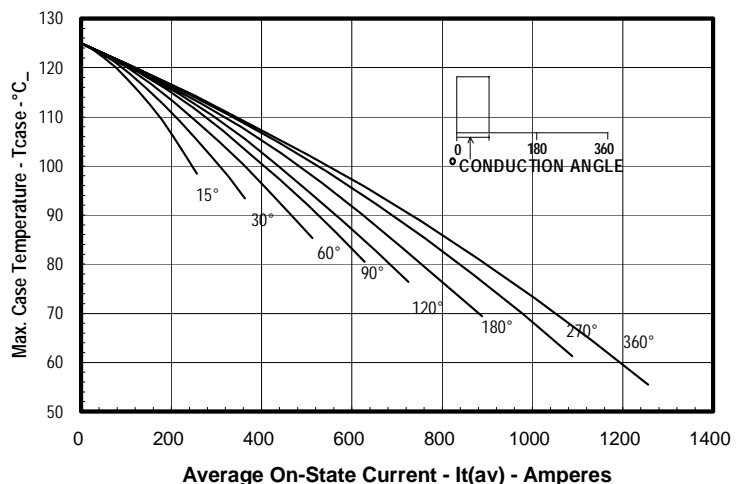

Powerex, Inc., Hillis Street, Youngwood, Pennsylvania 15697 (724) 925-7272

AC Switch SCR Module
1550 Amps RMS / 1800 Volts

DIM.	INCHES	MILLIMETERS
A	7.80	198.1
B	4.00	101.6
C	2.68	68.1
D	6.44	163.6
E	3.44	87.4
F	.28	7.1
G	7.31	185.7
H	7.00	177.8
J	1.65	42
K	.21	5.3
L	.28	7.1
M	.281	7.1
N	.45	11.4
P	.54	13.7
Q	5.93	150.6
R	.19	4.8
S	.11	2.8
T	.48	12.2
U	2.28	58
V	2.54	64.5
W	4.93	125.2
X	3.81	96.8
Y	.03	.8
Z	2.00	50.8
AA	1.00	25.4
BB	.50	12.7
CC	1.00	25.4
DD	.406	10.3
FF	.66	16.8

