



T-25-19

T720/T730

Powerex, Inc. Hillis Street, Youngwood, Pennsylvania 15697 (412) 925-7272
 Powerex Europe, S.A., 428 Ave. G. Durand, BP107, 72003 LeMans, France (43) 72.75.15

Phase Control SCR
350-550 Amperes Avg
100-2200 Volts

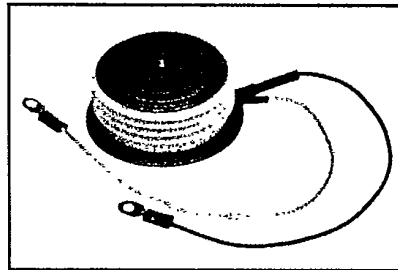
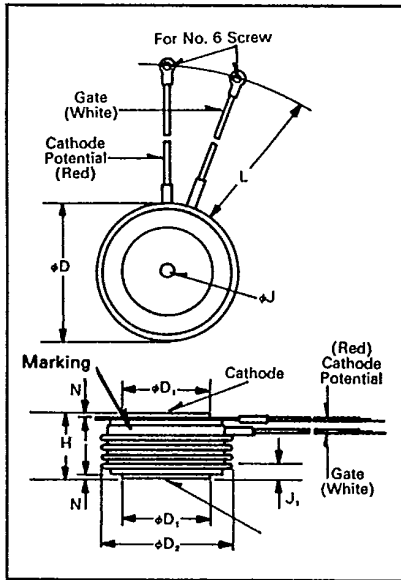

T720/T730
Phase Control SCR
 350-550 Amperes/100-2200 Volts

Description

Powerex Silicon Controlled Rectifiers (SCR) are designed for phase control applications. These are all-diffused, Press-Pak (Pow-R-Disc) devices employing the field-proven amplifying (di/namic) gate.

Features:

- Low On-State Voltage
- High di/dt
- High dv/dt
- Hermetic Packaging
- Excellent Surge and I²t Ratings

Applications:

- Power Supplies
- Battery Chargers
- Motor Control
- Light Dimmers
- VAR Generators

Ordering Information

Example: Select the complete eight digit part number you desire from the table - i.e. T7201045 is a 1000 Volt, 450 Ampere Phase Control SCR.

Type	Voltage*		Current	
	V _{DRM}	V _{RRM} Code	I _T (avg)	Code
T730	100	01	350	35
	200	02	450	45
	400	04	550	55
	600	06		
T720	800	08		
	1000	10		
	1200	12		
	1300	13		
	1400	14		
	1500	15		
	1600	16		
	1700	17		
	1800	18		
	2000	20		
2200	22			

*All voltages not available in all current ratings.

T72
Outline Drawing

Dimensions	Inches		Millimeters	
	Min.	Max.	Min.	Max.
φD	2.250	2.290	57.15	58.17
φD ₁	1.333	1.343	33.86	34.11
φD ₂	2.030	2.090	51.56	53.09
H	1.020	1.060	25.91	26.92
φJ	.135	.145	3.43	3.68
J ₁	.075	.090	1.91	2.29
L	7.75	8.50	196.85	215.90
N	.040	—	1.02	—

Creep Distance—1.00 in. min. (25.40 mm)
 Strike Distance—.69 in. min. (17.53 mm).
 (In accordance with NEMA standards.)
 Finish—Nickel Plate.
 Approx. Weight—8 oz. (227 g).
 1. Dimension "H" is clamped dimension.



Powerex, Inc., Hillis Street, Youngwood, Pennsylvania 15697 (412) 925-7272

Powerex Europe, S.A., 428 Ave. G. Durand, BP107, 72003 LeMans, France (43) 72.75.15

T720/T730

Phase Control SCR

350-550 Amperes Avg/100-2200 Volts

Absolute Maximum Ratings

	Symbol	T720 _ _ 35	T720 _ _ 45	T720 _ _ 55	Units
		T730 _ _ 35	T730 _ _ 45	T730 _ _ 55	
Maximum Blocking Voltage	V_{DRM}, V_{RRM}	2200	2200	1800	Volts
RMS On-State Current	$I_{T(RMS)}$	550	700	850	Amperes
Average On-State Current	$I_{T(av)}$	350	450	550	Amperes
Peak One-Cycle Surge (Non-Repetitive) On-State Current (60Hz) [Ⓢ]	I_{TSM}	7000	8400	10,000	Amperes
Peak One-Cycle Surge (Non-Repetitive) On-State Current (50Hz) [Ⓢ]	I_{TSM}	6400	7650	9125	Amperes
Critical Rate-of-Rise of On-State Current (Non-Repetitive) [Ⓢ] [Ⓢ] [Ⓢ]	di/dt	600	600	600	Amperes/μs
Critical Rate-of-Rise of On-State Current (Repetitive)	di/dt	150	150	150	Amperes/μs
I ² t (for Fusing), 8.3 milliseconds	I ² t	205,000	295,000	416,000	A ² sec
Peak Gate Power Dissipation	P _{GM}	16	16	16	Watts
Average Gate Power Dissipation	P _{G(av)}	3	3	3	Watts
Storage Temperature	T _{STG}	-40 to 150	-40 to 150	-40 to 150	°C
Operating Temperature	T _J	-40 to 125	-40 to 125	-40 to 125	°C
Mounting Force [Ⓢ]		2000 to 2400	2000 to 2400	2000 to 2400	lb.
Mounting Force [Ⓢ]		900 to 1090	900 to 1090	900 to 1090	kg

Ⓢ Consult recommended mounting procedures.

Ⓢ Applies for zero or negative gate bias.

Ⓢ Per JEDEC RS-397, 5.2.2.1.

Ⓢ With recommended gate drive.

Ⓢ Higher dv/dt ratings available, consult factory.

Ⓢ Per JEDEC standard RS-397, 5.2.2.6.



Powerex, Inc., Hills Street, Youngwood, Pennsylvania 15697 (412) 925-7272

Powerex Europe, S.A., 428 Ave. G. Durand, BP107, 72003 LeMans, France (43) 72.75.15

T720/T730

Phase Control SCR

350-550 Amperes Avg/100-2200 Volts

Electrical and Thermal Characteristics

	Symbol	Test Conditions	T720 _ _ 35	T720 _ _ 45	T720 _ _ 55	Units
			T730 _ _ 35	T730 _ _ 45	T730 _ _ 55	
Current—Conducting State Maximums						
Peak On-State Voltage	V_{TM}	$I_{TM} = 625A, T_J = 25^\circ C$	1.80	1.60	1.40	Volts
			T720/T730			
Voltage—Blocking State Maximums[ⓐ]						
Forward Leakage, Peak	I_{DRM}	$T_J = 125^\circ C, V_{DRM} = \text{rated}$		30		mA
Reverse Leakage, Peak	I_{RRM}	$T_J = 125^\circ C, V_{RRM} = \text{rated}$		30		mA
Switching						
Typical Turn-Off Time	t_q	$I_T = 250A, T_J = 125^\circ C,$ $di_T/dt = 25A/\mu\text{sec},$ reapplied $dv/dt = 20V/\mu\text{sec}$ linear to $0.8V_{DRM}$		150		μsec
Typical Turn-On Time [ⓑ]	t_{on}	$I_T = 100A, V_D = 100V$		7		μsec
Min. Critical dv/dt exponential to V_{DRM} [ⓐ]	dv/dt	$T_J = 125^\circ C$		300		$V/\mu\text{sec}$
Thermal						
Maximum Thermal Resistance, [ⓐ] double sided cooling						
Junction to Case	$R_{\theta JC}$.06		$^\circ C/\text{Watt}$
Case to Sink, Lubricated	$R_{\theta CS}$.02		$^\circ C/\text{Watt}$
Gate—Maximum Parameters						
Gate Current to Trigger	I_{GT}	$T_J = 25^\circ C, V_D = 12V$		150		mA
Gate Voltage to Trigger	V_{GT}	$T_J = 25^\circ C, V_D = 12V$		3		Volts
Non-Triggering Gate Voltage	V_{GDM}	$T_J = 125^\circ C, \text{rated } V_{DRM}$.15		Volts
Peak Forward Gate Current	I_{GTM}			4		Amperes
Peak Reverse Gate Voltage	V_{GRM}			5		Volts

ⓐ Consult recommended mounting procedures.

ⓑ Applies for zero or negative gate bias.

ⓒ Per JEDEC RS-397, 5.2.2.1.

ⓓ With recommended gate drive.

ⓔ Higher dv/dt ratings available, consult factory.

ⓕ Per JEDEC standard RS-397, 5.2.2.6.



Powerex, Inc., Hillis Street, Youngwood, Pennsylvania 15697 (412) 925-7272
 Powerex Europe, S.A., 428 Ave. G. Durand, BP107, 72003 LeMans, France (43) 72.75.15

T720/T730
Phase Control SCR
 350-550 Amperes Avg/100-2200 Volts

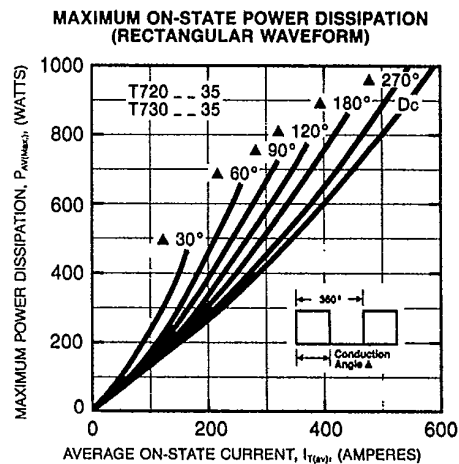
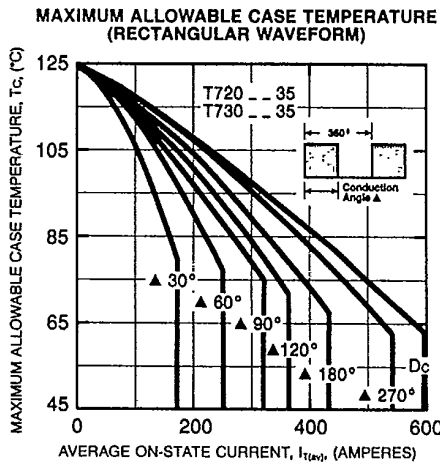
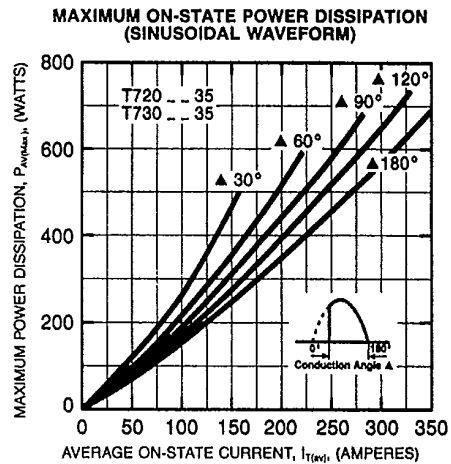
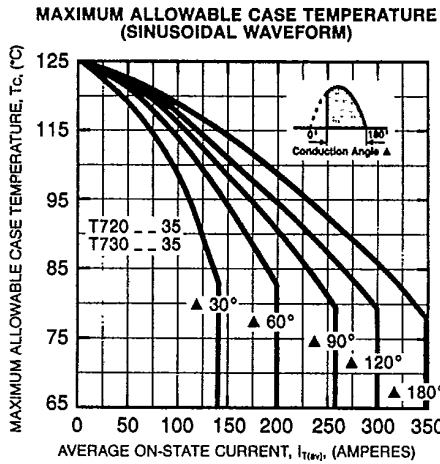
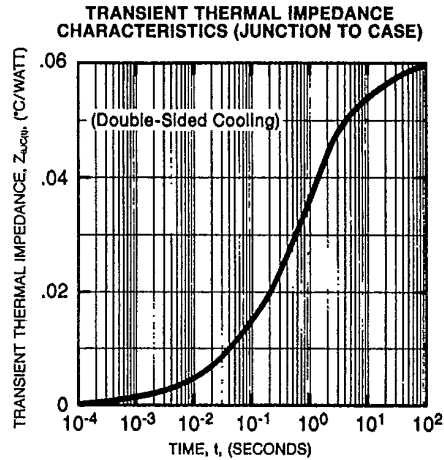
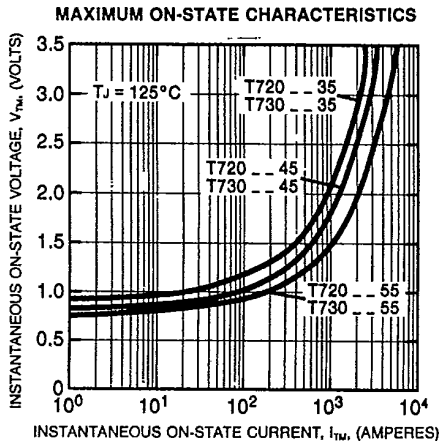



Powerex, Inc., Hillis Street, Youngwood, Pennsylvania 15697 (412) 925-7272

Powerex Europe, S.A., 428 Ave. G. Durand, BP107, 72003 LeMans, France (43) 72.75.15

T720/T730

Phase Control SCR

350-550 Amperes Avg/100-2200 Volts

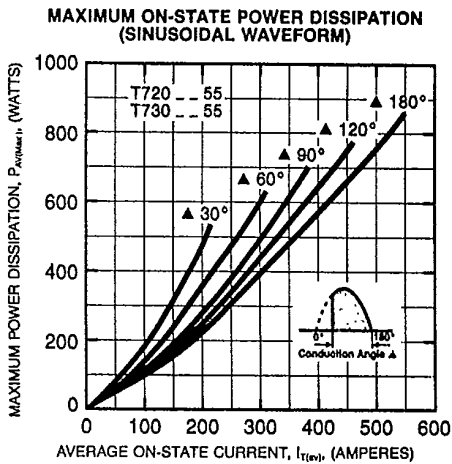
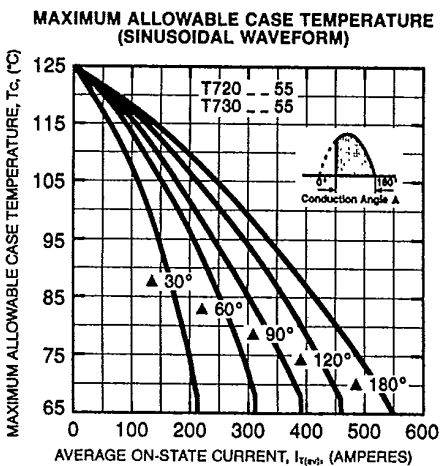
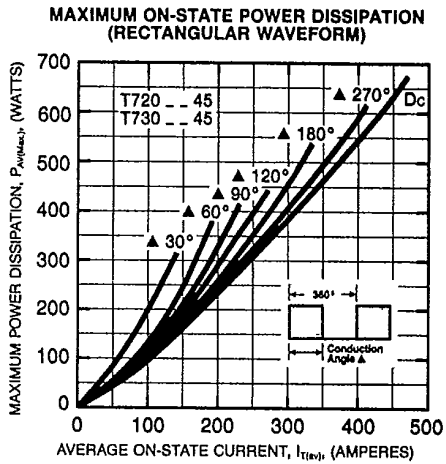
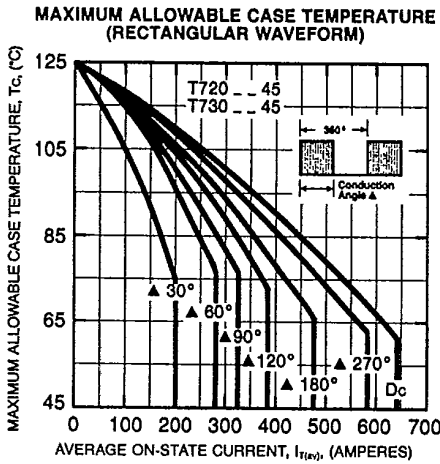
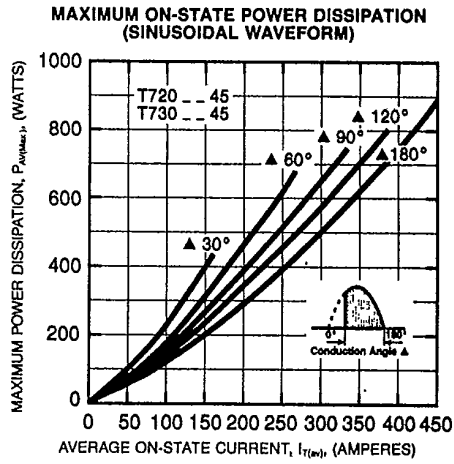
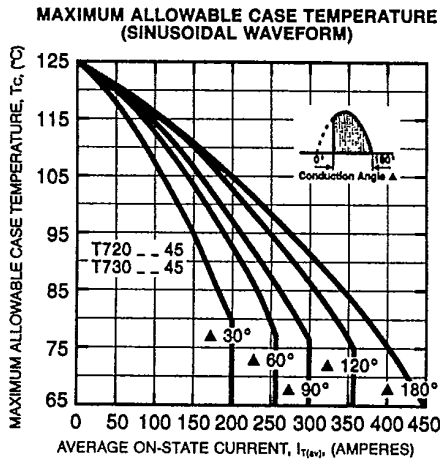



Powerex, Inc., Hillis Street, Youngwood, Pennsylvania 15697 (412) 925-7272
 Powerex Europe, S.A., 428 Ave. G. Durand, BP107, 72003 LeMans, France (43) 72.75.15

T720/T730
 Phase Control SCR
 350-550 Amperes Avg/100-2200 Volts

