

■ OUTLINE

The R1221N Series are PWM step-down DC/DC Converter controllers embedded with a voltage detector, with low supply current by CMOS process.

Each step-down DC/DC converter in these ICs consists of an oscillator, a PWM control circuit, a reference voltage unit, an error amplifier, a soft-start circuit, a protection circuit, a PWM/VFM alternative circuit, a chip enable circuit, and resistors for voltage detection. A low ripple, high efficiency step-down DC/DC converter can be composed of this IC with only four external components, or a power-transistor, an inductor, a diode and a capacitor.

The output voltage of DC/DC converter can be supervised by the built-in voltage detector.

With a PWM/VFM alternative circuit, when the load current is small, the operation turns into the VFM oscillator from PWM oscillator automatically, therefore the efficiency at small load current is improved.

And the PWM/VFM alternative circuit is an option, in terms of C version and D version, the circuit is not included.

If the term of maximum duty cycle keeps on a certain time, the embedded protection circuit works. There are two types of protection function. One is latch-type protection circuit, and it works to latch an external Power MOS with keeping it disable. To release the condition of protection, after disable this IC with a chip enable circuit, enable it again, or restart this IC with power-on. The other is Reset-type protection circuit, and it works to restart the operation with soft-start and repeat this operation until maximum duty cycle condition is released. Either of these protection circuits can be designated by users' request.

■ FEATURES

- Wide Range of Input Voltage 2.3V to 13.2V
- Built-in Soft-start Function and two choices of Protection Function(Latch-type or Reset-type)
- Two choices of Oscillator Frequency 300kHz, 500kHz
- High Efficiency TYP. 90%
- Standby Current TYP. 0 μ A
- Setting Output Voltage Stepwise setting with a step of 0.1V in the range of 1.5V to 5.0V
- High Accuracy Output Voltage $\pm 2.0\%$
- Setting Detector Threshold Voltage Stepwise setting with a step of 0.1V in the range of 1.2V to 4.5V
- High Accuracy Detector Threshold Voltage $\pm 2.0\%$
- Low Temperature-Drift Coefficient of Output Voltage • TYP. $\pm 100\text{ppm}/^\circ\text{C}$

■ APPLICATIONS

- Power source for hand-held communication equipment, cameras, video instruments such as VCRs, camcorders.
- Power source for battery-powered equipment.
- Power source for household electrical appliances.

■ BLOCK DIAGRAM

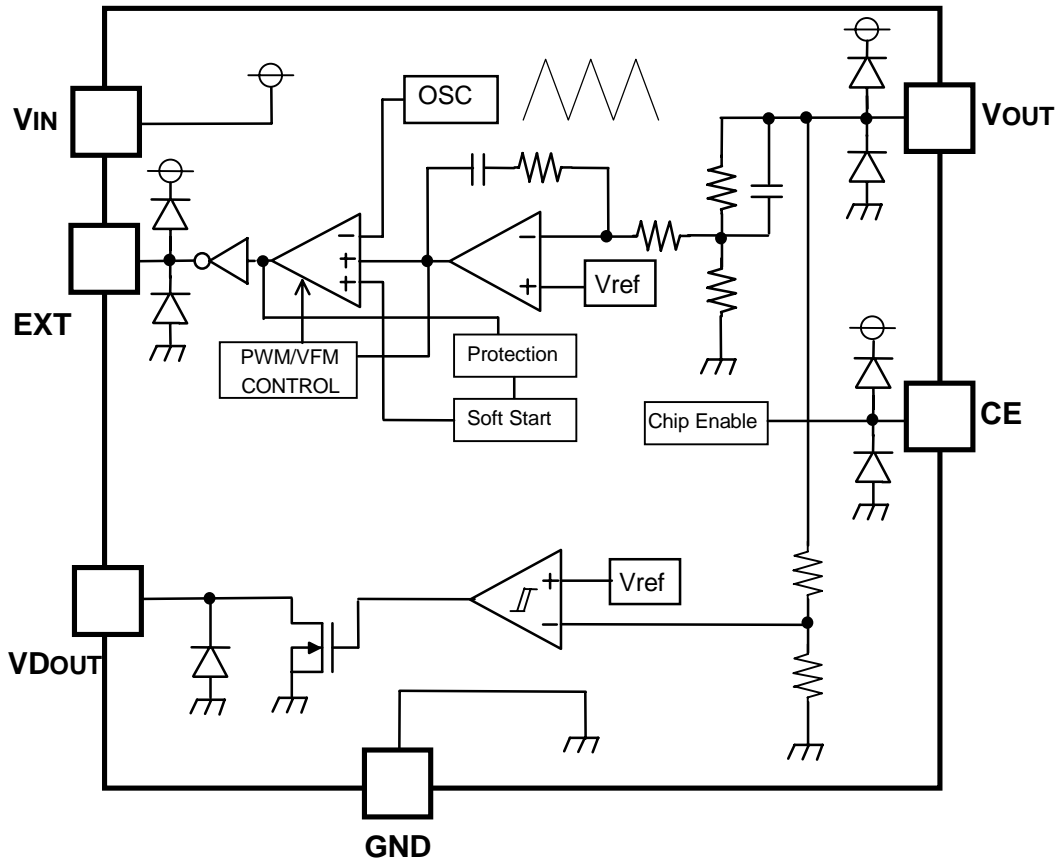

■ SELECTION GUIDE

In the R1221N Series, the output voltage, the detector threshold, the oscillator frequency, the optional function, and the taping type for the ICs can be selected at the user's request.

The selection can be made by designating the part number as shown below;

R1221NXXXX-TR

↑ ↑ ↑
a b c

Code	Contents
a	Setting Output Voltage(VOUT): Stepwise setting with a step of 0.1V in the range of 1.5V to 5.0V is possible.
b	Setting Detector Threshold(-VDET) Stepwise setting with a step of 0.1V in the range of 1.2V to 4.5V is possible. A:3.0V
c	Designation of Oscillator Frequency and Optional Function A:300kHz, with a PWM/VFM alternative circuit, Latch-type protection B:500kHz, with a PWM/VFM alternative circuit, Latch-type protection C:300kHz, without a PWM/VFM alternative circuit, Latch-type protection D:500kHz, without a PWM/VFM alternative circuit, Latch-type protection E:300kHz, with a PWM/VFM alternative circuit, Reset-type protection F:500kHz, with a PWM/VFM alternative circuit, Reset-type protection G:300kHz, without a PWM/VFM alternative circuit, Reset-type protection H:500kHz, without a PWM/VFM alternative circuit, Reset-type protection

■ PIN CONFIGURATION

● SOT-23-6W

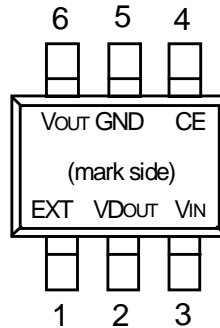

■ PIN DESCRIPTION

Pin No.	Symbol	Description
1	EXT	External Transistor Drive Pin (Output Type ; CMOS)
2	VDOUT	Voltage Detector Output Pin (Output Type ; Nch Open Drain)
3	VIN	Power Supply Pin
4	CE	Chip Enable Pin
5	GND	Ground Pin
6	VOUT	Pin for Monitoring Output Voltage

■ ABSOLUTE MAXIMUM RATING

Symbol	Item	Rating	Unit
VIN	VIN Supply Voltage	15	V
VEXT	EXT Pin Output Voltage	-0.3~VIN+0.3	V
VCE	CE Pin Input Voltage	-0.3~VIN+0.3	V
VDOUT	VDOUT Pin Output Voltage	-0.3~15	V
VOUT	VOUT Pin Input Voltage	-0.3~VIN+0.3	V
IEXT	EXT Pin Inductor Drive Output Current	±25	mA
PD	Power Dissipation	250	mW
Topt	Operating Temperature Range	-40~+85	°C
Tstg	Storage Temperature Range	-55~+125	°C

■ ELECTRICAL CHARACTERISTICS

●R1221N***A(C,E,G) Output Voltage : Vo, Detector Threshold : VD (Topt=25°C)

Symbol	Item	Conditions	MIN.	TYP.	MAX.	Note*	Unit
VIN	Operating Input Voltage		2.3		13.2		V
VOUT	Step-down Output Voltage	VIN=VCE=Vo+1.2V, IOUT=-10mA	Vo× 0.98	Vo	Vo× 1.02	A	V
ΔVOUT/ ΔT	Step-down Output Voltage Temperature Coefficient	-40°C ≤ Topt ≤ 85°C		±100			ppm/ °C
fosc	Oscillator Frequency	VIN=VCE=Vo+1.2V, IOUT=-100mA	240	300	360	A	kHz
Δfosc/ ΔT	Frequency Temperature Coefficient	-40°C ≤ Topt ≤ 85°C		±0.3			%/ °C
IDD1	Supply Current1	VIN=13.2V, VCE=13.2V, VOUT=13.2V		100	160	B	μA
Istb	Standby Current	VIN=13.2V, VCE=0V, VOUT=0V		0	0.5	C	μA
IEXTH	EXT "H" Output Current	VIN=8V, VEXT=7.9V, VOUT=8V, VCE=8V		-10	-6	D	mA
IEXTL	EXT "L" Output Current	VIN=8V, VEXT=0.1V, VOUT=0V, VCE=0V	10	20		D	mA
ICEH	CE "H" Input Current	VIN=13.2V, VCE=13.2V, VOUT=13.2V		0	0.5	E	μA
ICEL	CE "L" Input Current	VIN=13.2V, VCE=0V, VOUT=13.2V	-0.5	0		E	μA
VCEH	CE "H" Input Voltage	VIN=8V, VCE=0V→1.5V		0.8	1.2	F	V
VCEL	CE "L" Input Voltage	VIN=8V, VCE=1.5V→0V	0.3	0.8		F	V
Maxdty	Oscillator Maximum Duty Cycle		100				%
VFMdty	VFM Duty Cycle	Applied to B and F versions only		25			%
Tstart	Delay Time by Soft-Start function	VIN=Vo+1.2V, VCE=0V→Vo+1.2V At 80% of rising	5	10	16	F	ms
Tprot	Delay Time for protection circuit	VIN=Vo+1.2V, VCE=Vo+1.2V→0V	1	3	5	G	ms
IVDLK	VDOUT Output Leakage Current	VIN=VOUT=VCE=VDOUT=8V		0	0.5	I	μA
IVDL	VDOUT "L" Output Current	VIN=VOUT=2.3V, VCE=0V, VDOUT=0.1V	0.5	1		I	mA
-VDET	Detector Threshold	VIN=6V, VCE=6V, VOUT=VD×1.2V→0V	VD× 0.98	VD	VD× 1.02	J	V
tVDET	Output Delay Time for Released Voltage	VIN=6V, VCE=6V, VOUT=0V→VD×1.2V At 80% of rising	2	5	10	J	ms
VHYS	Detector Threshold Hysteresis	VIN=6V, VCE=6V, VOUT=0V→VD×1.2V	VD× 0.01	VD× 0.03	VD× 0.05	J	mV
Δ-VDET/ ΔT	Detector Threshold Temperature Coefficient	-40°C ≤ Topt ≤ 85°C		±100			ppm/ °C

Note: Refer to Test Circuits

●R1221N***B(D,F,H) Output Voltage : Vo, Detector Threshold : Vd

(Topt=25°C)

Symbol	Item	Conditions	MIN.	TYP.	MAX.	Note*	Unit
VIN	Operating Input Voltage		2.3		13.2		V
VOUT	Step-down Output Voltage	VIN=VCE=Vo+1.2V, IOUT=-10mA	Vo× 0.98	Vo	Vo× 1.02	A	V
ΔVOUT/ ΔT	Step-down Output Voltage Temperature Coefficient	-40°C ≤ Topt ≤ 85°C		±100			ppm/ °C
fosc	Oscillator Frequency	VIN=VCE=Vo+1.2V, IOUT=-100mA	400	500	600	A	kHz
ΔfOSC/ ΔT	Frequency Temperature Coefficient	-40°C ≤ Topt ≤ 85°C		±0.3			%/ °C
IDD1	Supply Current1	VIN=13.2V, VCE=13.2V, VOUT=13.2V		140	200	B	μA
Istb	Standby Current	VIN=13.2V, VCE=0V, VOUT=0V		0	0.5	C	μA
IEXTH	EXT "H" Output Current	VIN=8V, VEXT=7.9V, VOUT=8V, VCE=8V		-10	-6	D	mA
IEXTL	EXT "L" Output Current	VIN=8V, VEXT=0.1V, VOUT=0V, VCE=0V	10	20		D	mA
ICEH	CE "H" Input Current	VIN=13.2V, VCE=13.2V, VOUT=13.2V		0	0.5	E	μA
ICEL	CE "L" Input Current	VIN=13.2V, VCE=0V, VOUT=13.2V	-0.5	0		E	μA
VCEH	CE "H" Input Voltage	VIN=8V, VCE=0V→1.5V		0.8	1.2	F	V
VCEL	CE "L" Input Voltage	VIN=8V, VCE=1.5V→0V	0.3	0.8		F	V
Maxdty	Oscillator Maximum Duty Cycle		100				%
VFMdty	VFM Duty Cycle	Applied to B and F versions only		25			%
Tstart	Delay Time by Soft-Start function	VIN=Vo+1.2V, VCE=0V→Vo+1.2V At 80% of rising	3	6	10	F	ms
Tprot	Delay Time for protection circuit	VIN=Vo+1.2V, VCE=Vo+1.2V→0V	1	2	4	G	ms
IVDLK	VDOUT Output Leakage Current	VIN=VOUT=VCE=VDOUT=8V		0	0.5	I	μA
IVDL	VDOUT "L" Output Current	VIN=VOUT=2.3V, VCE=0V, VDOUT=0.1V	0.5	1		I	mA
-VDET	Detector Threshold	VIN=6V, VCE=6V, VOUT=VD×1.2V→0V	VD× 0.98	Vd	VD× 1.02	J	V
tVDET	Output Delay Time for Released Voltage	VIN=6V, VCE=6V, VOUT=0V→VD×1.2V At 80% of rising	1.5	3.5	6.0	J	ms
VHYS	Detector Threshold Hysteresis	VIN=6V, VCE=6V, VOUT=0V→VD×1.2V	VD× 0.01	VD× 0.03	VD× 0.05	J	mV
Δ-VDET/ ΔT	Detector Threshold Temperature Coefficient	-40°C ≤ Topt ≤ 85°C		±100			ppm/ °C

Note: Refer to Test Circuits

TEST CIRCUITS

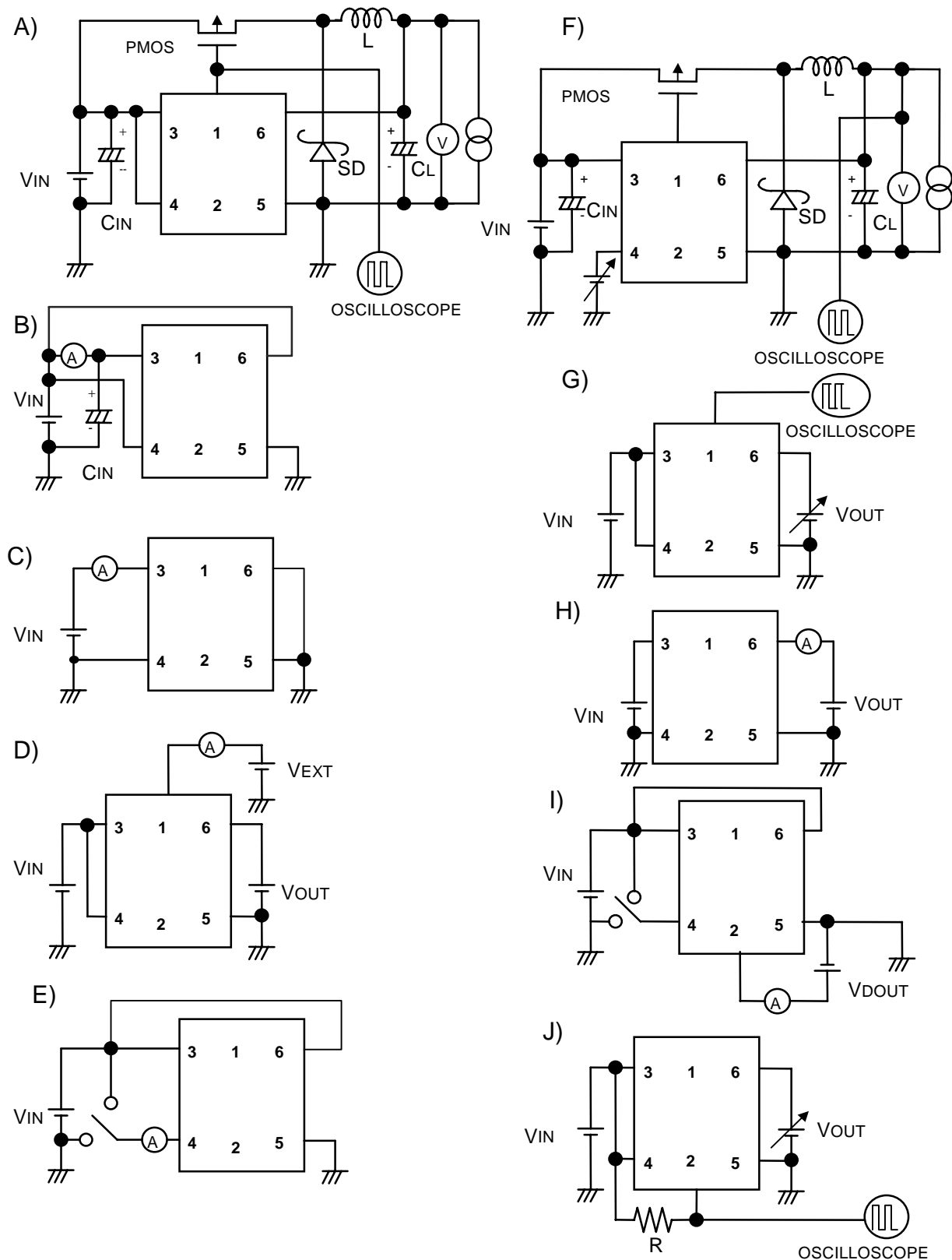

Inductor L : 27 μ H(Sumida Electronic, CD104)
 Capacitor CL: 47 μ F(Tantalum type)
 Power MOS PMOS : HAT1020R(Hitachi)

Diode SD : RB491D (Rohm, Schottky type)
 CIN : 22 μ F(Tantalum type)
 Resistor R : 100k Ω

■ TYPICAL APPLICATIONS AND APPLICATION HINTS

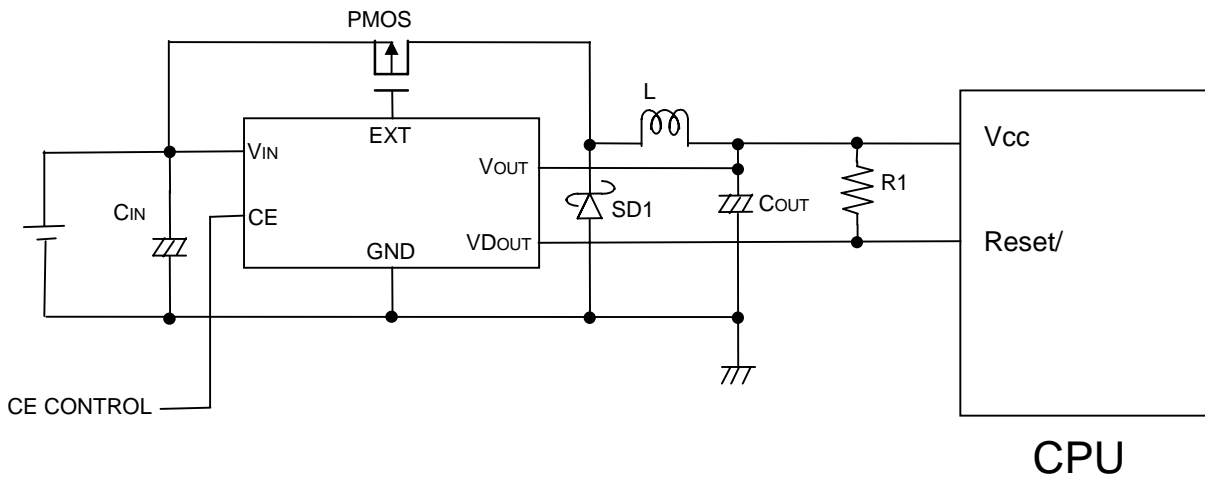

PMOS: HAT1020R (Hitachi), Si3443DV (Siliconix)

L : CD105(Sumida, 27 μ H)

SD1 : RB491D (Rohm)

COUT : 47 μ F(Tantalum Type)

CIN :10 μ F(Tantalum Type)

R1 : 100k Ω

When you use these ICs, consider the following issues;

- As shown in the block diagram, a parasitic diode is formed in each terminal, each of these diodes is not formed for load current, therefore do not use it in such a way. When you control the CE pin by another power supply, do not make its "H" level more than the voltage level of VIN pin.
- Detector threshold hysteresis is set at 3 percent of detector threshold voltage. (Min. 1 percent, Max. 5 percent)
- Setting Detector threshold voltage range depends on Output voltage of DC/DC converter.
Release Voltage from Reset condition must not be more than Output voltage of DC/DC converter.
(Detector Threshold Voltage \times 1.07 < Output Voltage of DC/DC converter \times 0.98)
- When the R1221NXXXX is on stand-by mode, the output voltage of VDOUT is GND level, therefore if the pull-up resistor for VDOUT pin is pulled up another power supply, a certain amount of current is loading through the resistor.
- The operation of Latch-type protection circuit is as follows;
When the maximum duty cycle continues longer than the delay time for protection circuit, (Refer to the Electrical Characteristics) the protection circuit works to shut-down the external Power MOS with its latching operation. Therefore when an input/output voltage difference is small, the protection circuit may work even at small load current.
To release the protection state, after disable this IC with a chip enable circuit, enable it again, or restart this IC with power-on. However, in the case of restarting this IC with power-on, after the power supply is turned off, if a certain amount of charge remains in CIN, or some voltage is forced to VIN from CIN, this IC might not be restarted even after power-on.
If rising transition speed of supply voltage is too slow, or the time which is required for VIN voltage to reach Output Voltage of DC/DC converter is longer than soft-starting time plus delay time for protection circuit, protection circuit works before VIN voltage reaches Output Voltage of DC/DC converter. To avoid this condition, make this IC disable(CE="L") first, then force VIN voltage, and after VIN voltage becomes equal or more than VOUT, make this IC enable(CE="H").
- Set external components as close as possible to the IC and minimize the connection between the components and the IC. In particular, a capacitor should be connected to VOUT pin with the minimum connection. And make sufficient grounding and reinforce supplying. A large switching current flows through the connection of power supply, an inductor and the connection of VOUT. If the impedance of power supply line is high, the voltage level of power supply of the IC fluctuates with the switching current. This may cause unstable operation of the IC.

- Use capacitors with a capacity of 22 μ F or more for V_{OUT} Pin, and with good high frequency characteristics such as tantalum capacitors. We recommend you to use capacitors with an allowable voltage which is at least twice as much as setting output voltage. This is because there may be a case where a spike-shaped high voltage is generated by an inductor when an external transistor is on and off.
- Choose an inductor that has sufficiently small D.C. resistance and large allowable current and is hard to reach magnetic saturation. And if the value of inductance of an inductor is extremely small, the I_{LX} may exceed the absolute maximum rating at the maximum loading.
Use an inductor with appropriate inductance.
- Use a diode of a Schottky type with high switching speed, and also pay attention to its current capacity.
- Do not use this IC under the condition at V_{IN} voltage less than minimum operating voltage.

☆ The performance of power source circuits using these ICs extremely depends upon the peripheral circuits. Pay attention in the selection of the peripheral circuits. In particular, design the peripheral circuits in a way that the values such as voltage, current, and power of each component, PCB patterns and the IC do not exceed their respected rated values.

■ OPERATION of step-down DC/DC converter and Output Current

The step-down DC/DC converter charges energy in the inductor when L_x transistor is ON, and discharges the energy from the inductor when L_x transistor is OFF and controls with less energy loss, so that a lower output voltage than the input voltage is obtained. The operation will be explained with reference to the following diagrams :

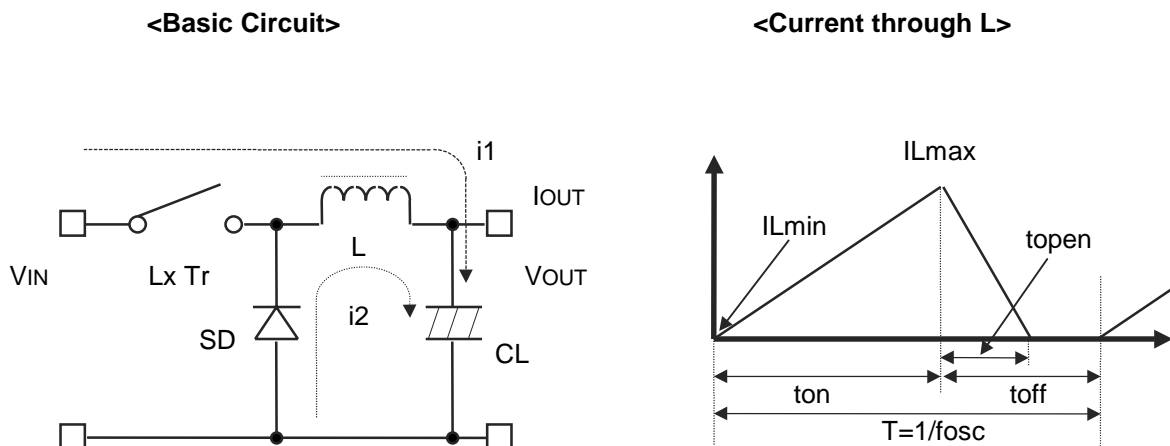

- Step 1 : L_xTr turns on and current I_L(=i₁) flows, and energy is charged into CL. At this moment, I_L increases from I_{Lmin}(=0) to reach I_{Lmax} in proportion to the on-time period(ton) of L_xTr.
- Step 2 : When L_xTr turns off, Schottky diode(SD) turns on in order that L maintains I_L at I_{Lmax}, and current I_L(=i₂) flows.
- Step 3 : I_L decreases gradually and reaches I_{Lmin} after a time period of topen, and SD turns off, provided that in the continuous mode, next cycle starts before I_L becomes to 0 because toff time is not enough. In this case, I_L value is from this I_{Lmin}(>0).

In the case of PWM control system, the output voltage is maintained by controlling the on-time period(ton), with the oscillator frequency(fosc) being maintained constant.

● Discontinuous Conduction Mode and Continuous Conduction Mode

The maximum value(I_{Lmax}) and the minimum value(I_{Lmin}) of the current which flows through the inductor are the same as those when L_xTr is ON and when it is OFF.

The difference between I_{Lmax} and I_{Lmin}, which is represented by ΔI ;

$$\Delta I = I_{Lmax} - I_{Lmin} = V_{OUT} \times t_{open} / L = (V_{IN} - V_{OUT}) \times t_{on} / L \dots \text{Equation 1}$$

wherein $T = 1/f_{osc} = t_{on} + t_{off}$

$$\text{duty}(\%) = t_{on} / T \times 100 = t_{on} \times f_{osc} \times 100$$

$$t_{open} \leq t_{off}$$

In Equation 1, $V_{OUT} \times t_{open}/L$ and $(V_{IN}-V_{OUT}) \times t_{on}/L$ are respectively show the change of the current at ON, and the change of the current at OFF.

When the output current(I_{OUT}) is relatively small, $t_{open} < t_{off}$ as illustrated in the above diagram. In this case, the energy is charged in the inductor during the time period of t_{on} and is discharged in its entirely during the time period of t_{off} , therefore I_{Lmin} becomes to zero($I_{Lmin}=0$). When I_{out} is gradually increased, eventually, t_{open} becomes to t_{off} ($t_{open} = t_{off}$), and when I_{OUT} is further increased, I_{Lmin} becomes larger than zero($I_{Lmin}>0$). The former mode is referred to as the discontinuous mode and the latter mode is referred to as continuous mode.

In the continuous mode, when Equation 1 is solved for t_{on} and assumed that the solution is t_{onc} ,

$$t_{onc} = T \times V_{IN}/V_{OUT} \dots \text{Equation 2}$$

When $t_{on} < t_{onc}$, the mode is the discontinuous mode, and when $t_{on} = t_{onc}$, the mode is the continuous mode.

■ OUTPUT CURRENT AND SELECTION OF EXTERNAL COMPONENTS

When LxTr is ON:

(Wherein, Ripple Current P-P value is described as I_{RP} , ON resistance of LXTr is described as R_p the direct current of the inductor is described as R_L .)

$$V_{IN} = V_{OUT} + (R_p + R_L) \times I_{OUT} + L \times I_{RP}/t_{on} \dots \text{Equation 3}$$

When LxTr is OFF:

$$L \times I_{RP}/t_{off} = V_F + V_{OUT} + R_L \times I_{OUT} \dots \text{Equation 4}$$

Put Equation 4 to Equation 3 and solve for ON duty, $t_{on}/(t_{off}+t_{on})=D_{ON}$,

$$D_{ON} = (V_{OUT} + V_F + R_L \times I_{OUT}) / (V_{IN} + V_F - R_p \times I_{OUT}) \dots \text{Equation 5}$$

Ripple Current is as follows;

$I_{RP} = (V_{IN} - V_{OUT} - R_p \times I_{OUT} - R_L \times I_{OUT}) \times D_{ON}/f/L \dots \text{Equation 6}$
wherein, peak current that flows through L, LxTr, and SD is as follows;

$$I_{Lmax} = I_{OUT} + I_{RP}/2 \dots \text{Equation 7}$$

Consider I_{Lmax} , condition of input and output and select external components.

★The above explanation is directed to the calculation in an ideal case in continuous mode.

■ External Components

1. Inductor

Select an inductor that peak current does not exceed I_{Lmax} . If larger current than allowable current flows, magnetic saturation occurs and make transform efficiency worse.

When the load current is same, the smaller value of L, the larger the ripple current.

Provided that the allowable current is large in that case and DC current is small, therefore, for large output current, efficiency is better than using an inductor with a large value of L and vice versa,

2. Diode

Use a diode with low V_F (Schottky type is recommended.) and high switching speed.

Reverse voltage rating should be more than V_{IN} and current rating should be equal or more than I_{Lmax} .

3. Capacitor

As for C_{IN} , use a capacitor with low ESR(Equivalent Series Resistance) and a capacity of at least $10\mu F$ for stable operation.

C_{OUT} can reduce ripple of Output Voltage, therefore $47\mu F$ to $100\mu F$ tantalum type is recommended.

4. Lx Transistor

Pch Power MOS FET is required for this IC.

Its breakdown voltage between gate and source should be a few volt higher than Input Voltage.

In the case of Input Voltage is low, to turn on MOS FET completely, select a MOS FET with low threshold voltage. If a large load current is necessary for your application and important, choose a MOS FET with low ON resistance for good efficiency.

If a small load current is mainly necessary for your application, choose a MOS FET with low gate capacity for good efficiency.

Maximum continuous drain current of MOS FET should be larger than peak current, I_{Lmax} .

■ TYPICAL CHARACTERISTICS

1) Output Voltage vs. Output Current

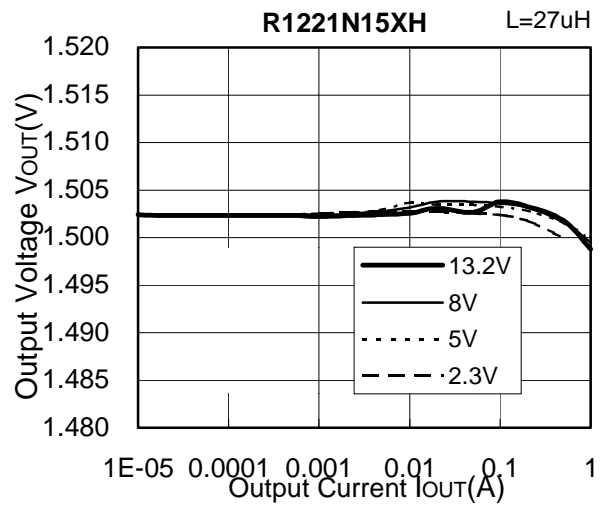
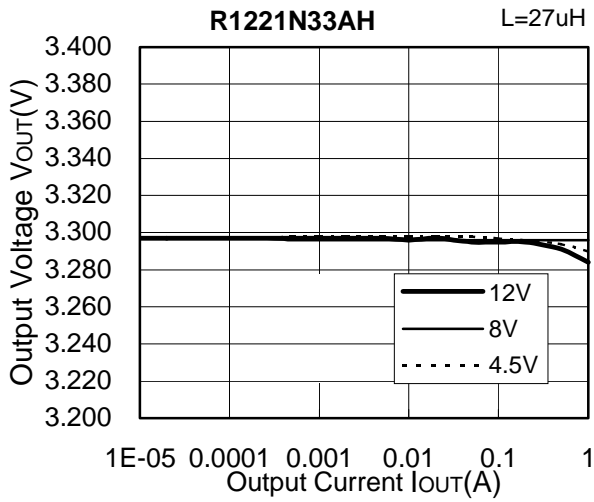

2) Efficiency vs. Output Current

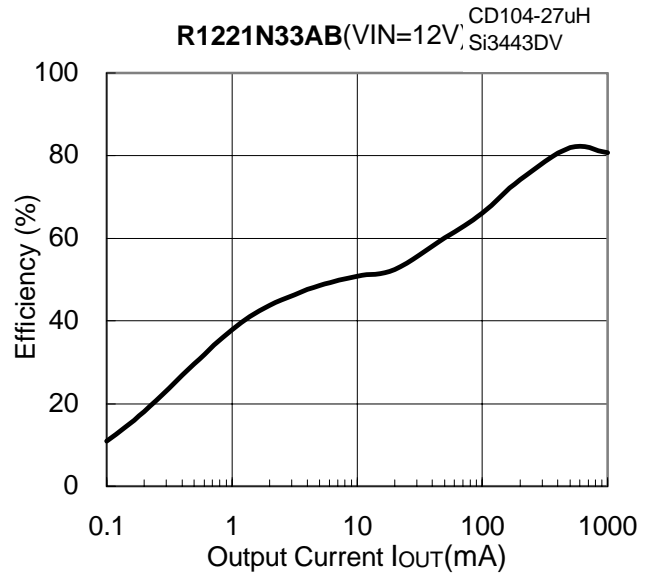
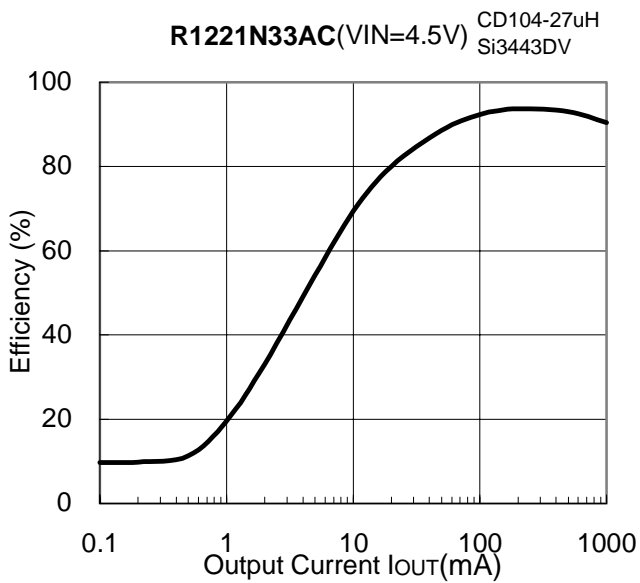
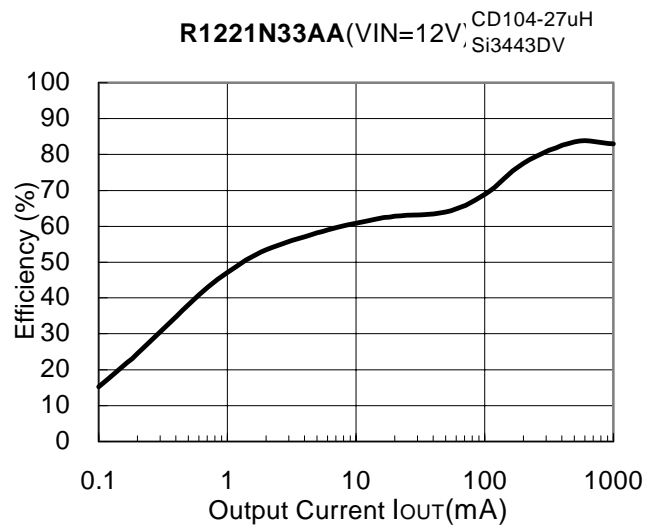
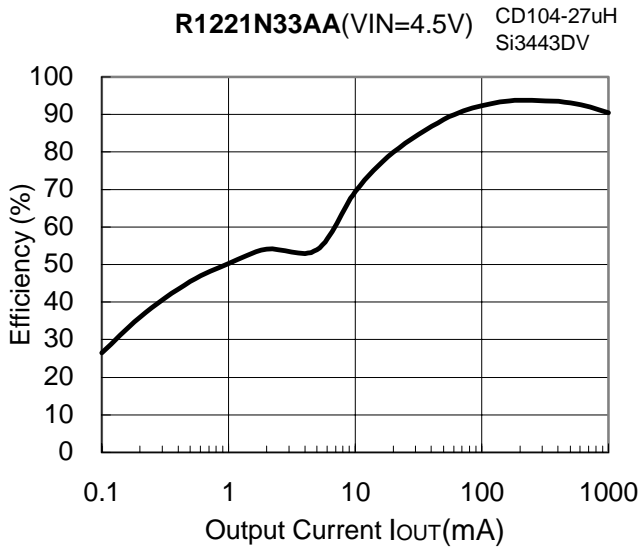

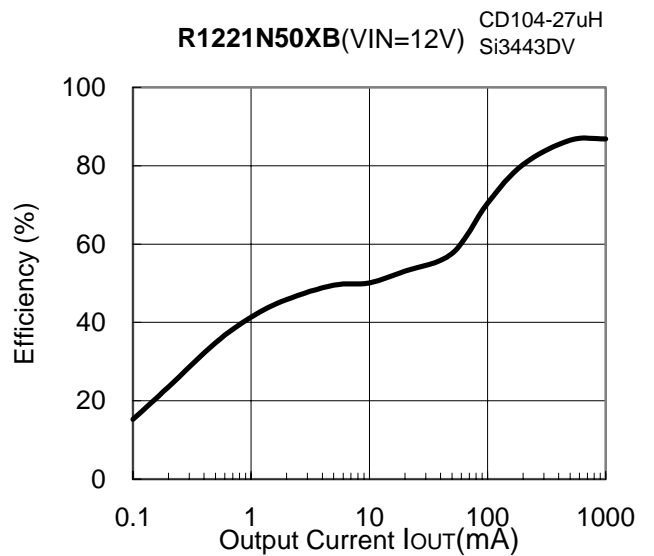
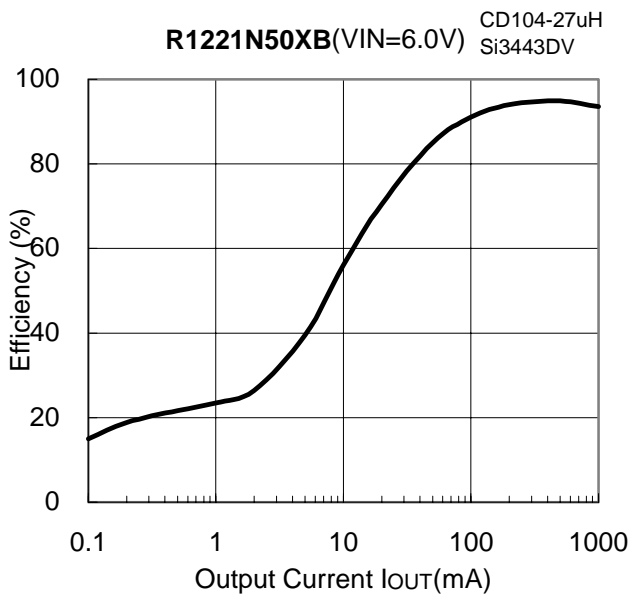
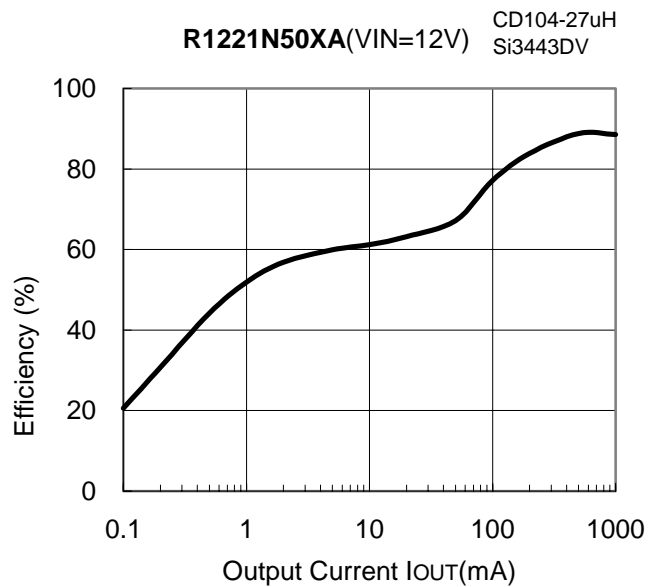
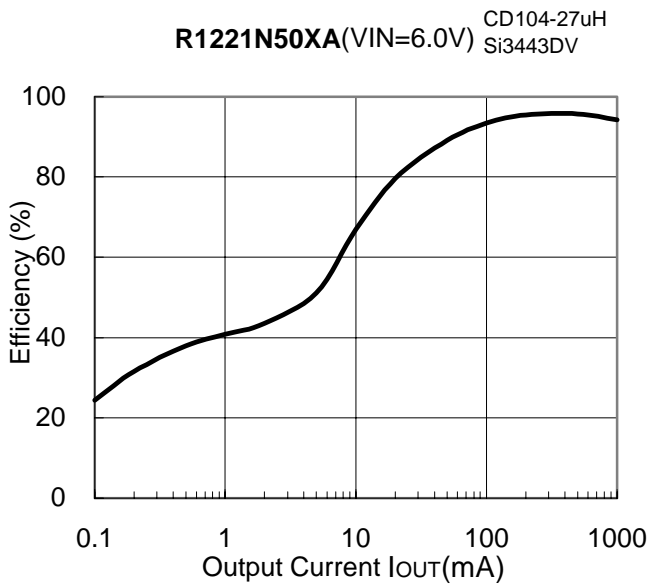
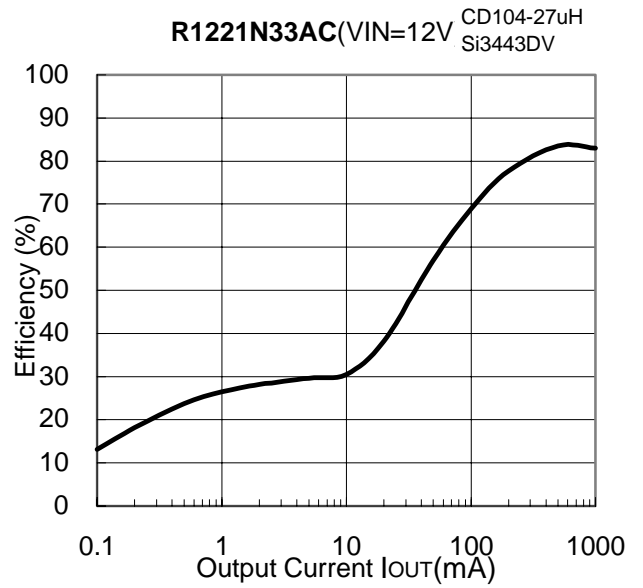
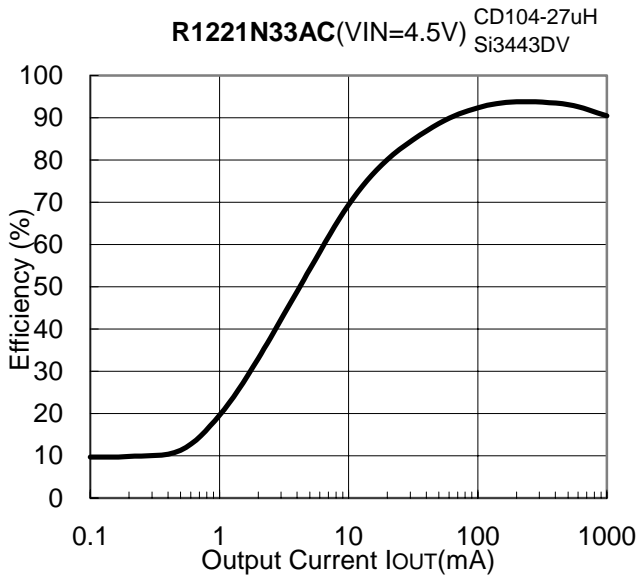

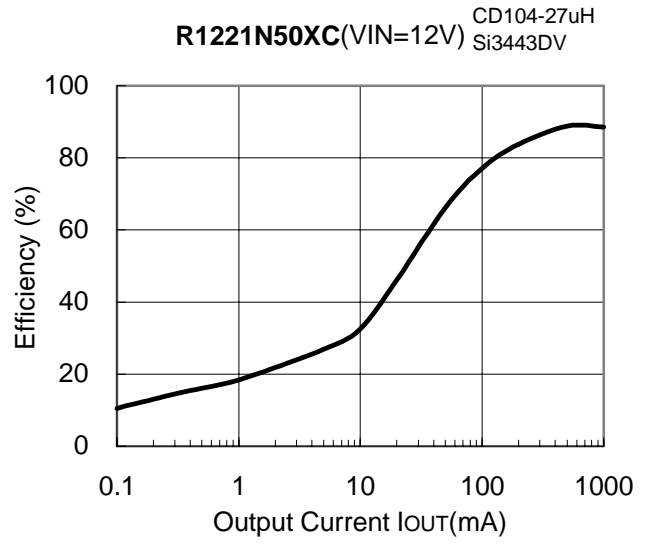
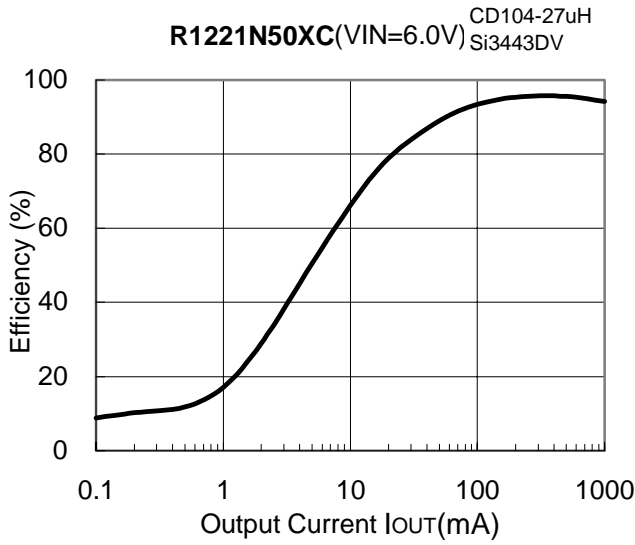

3) Ripple Voltage vs. Output Current

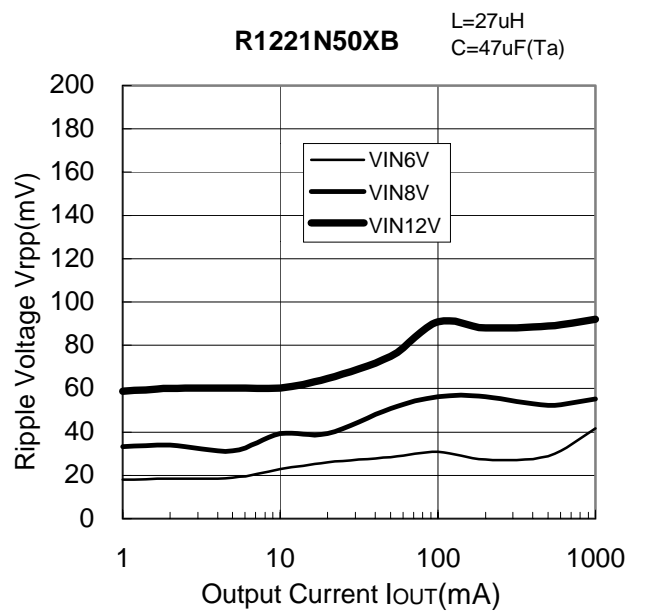
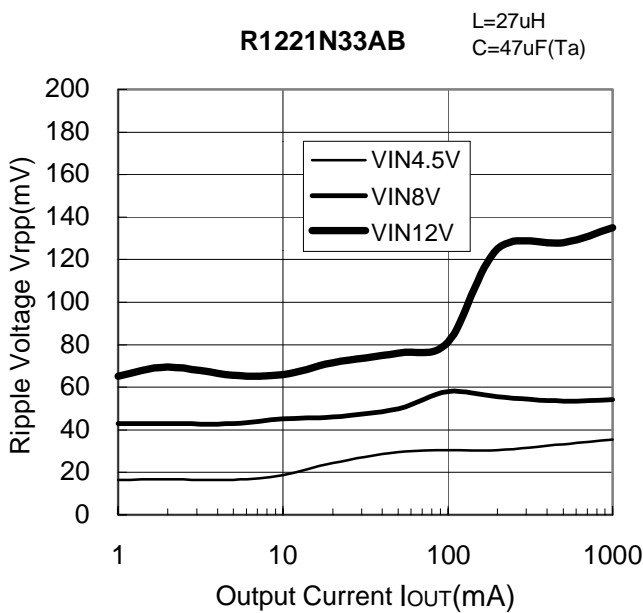
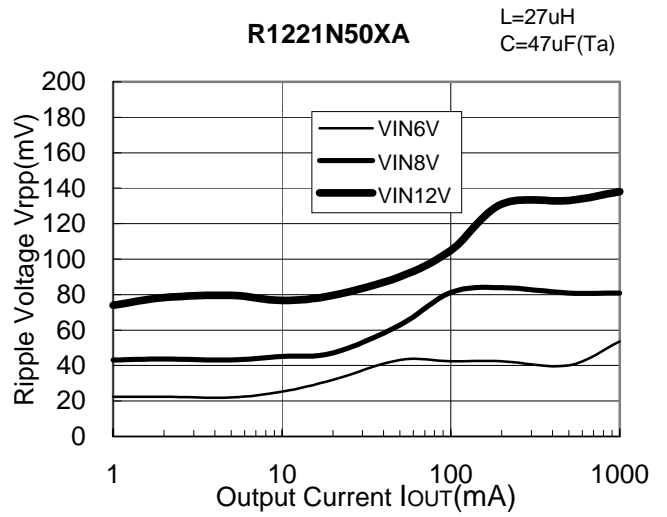
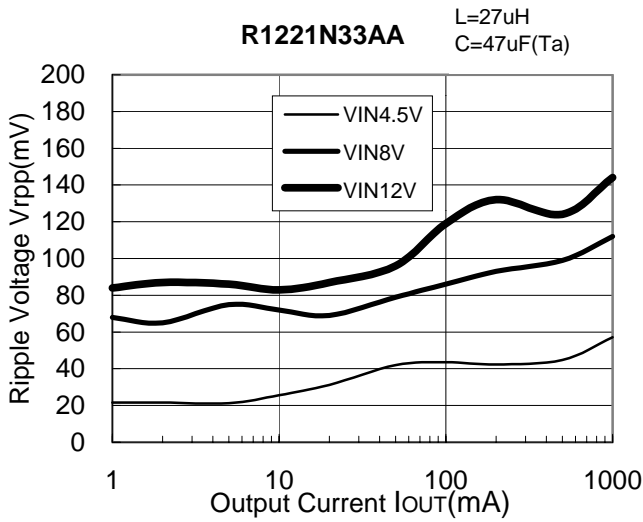

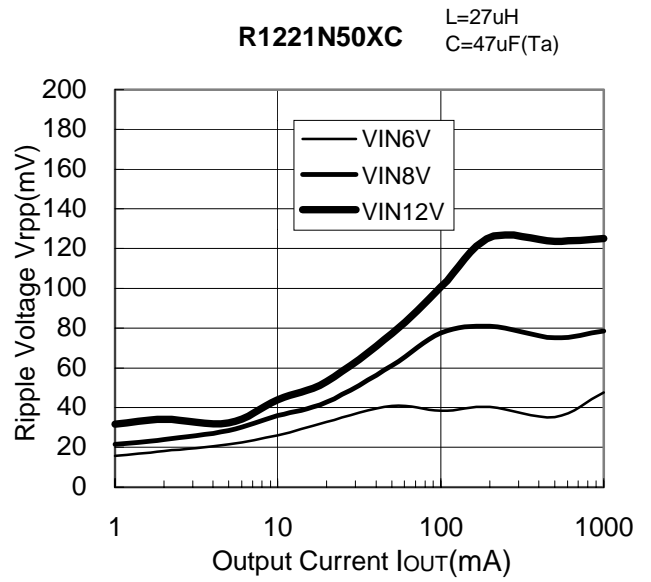
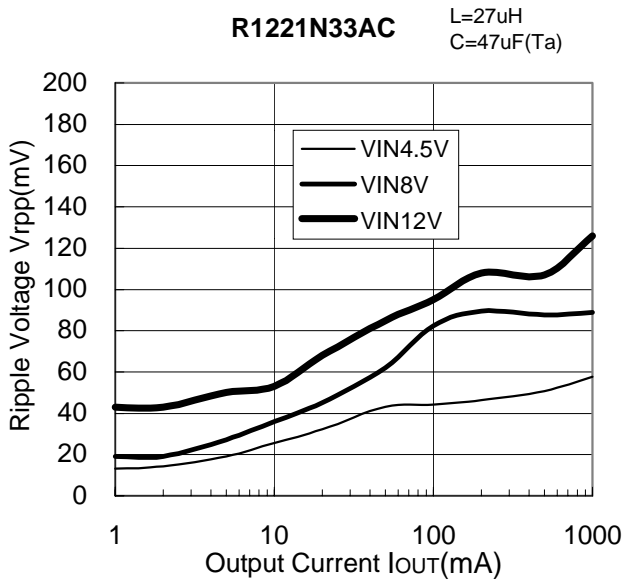

4) Oscillator Frequency vs. Input Voltage

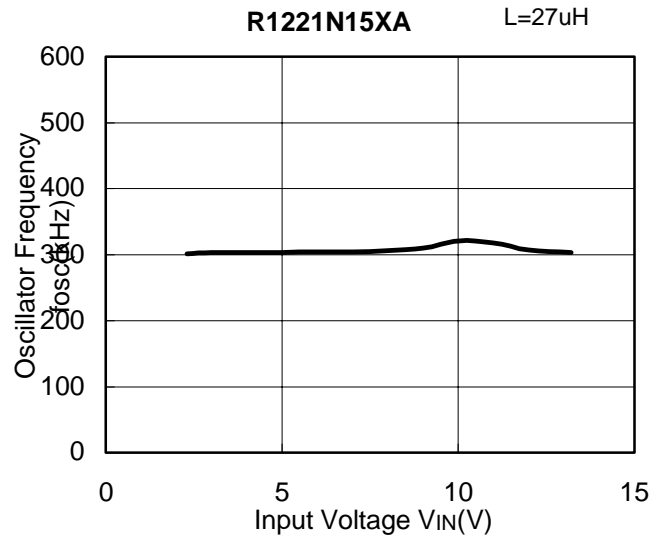
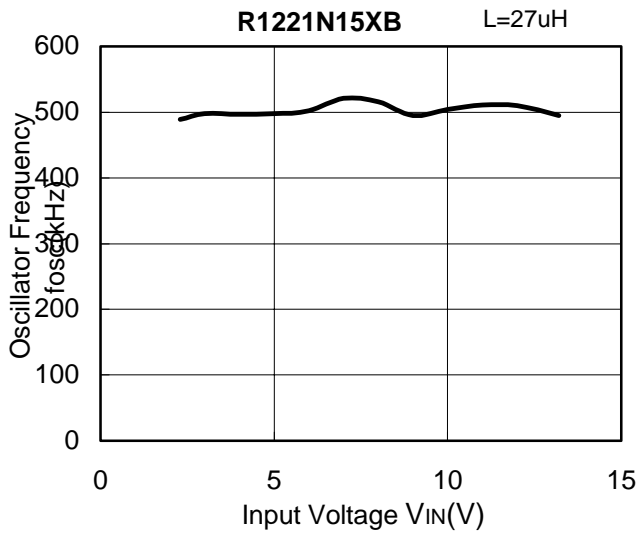

5) Output Voltage vs. Input Voltage

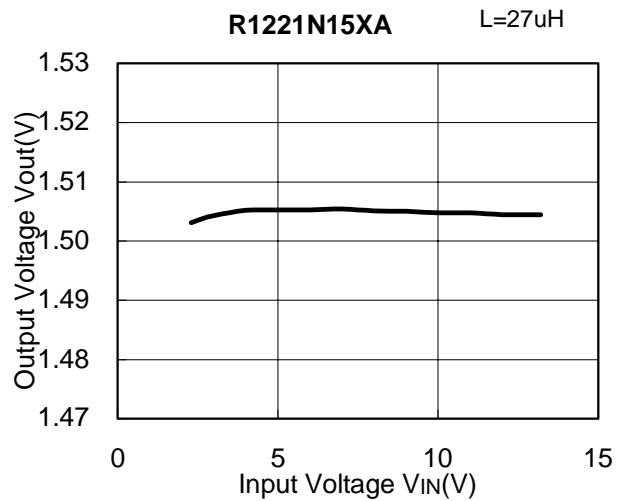
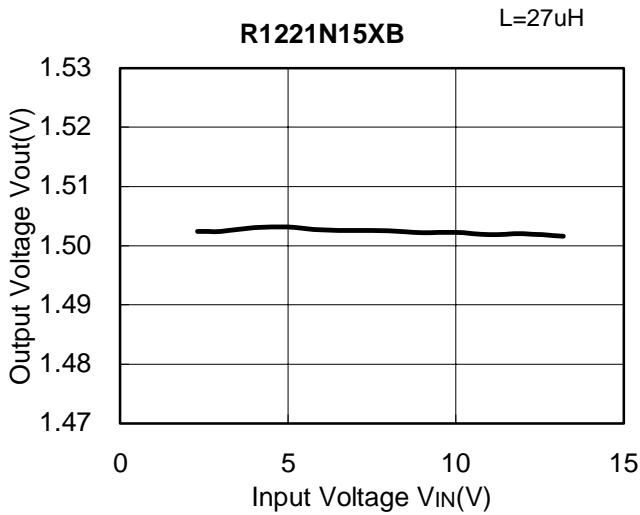

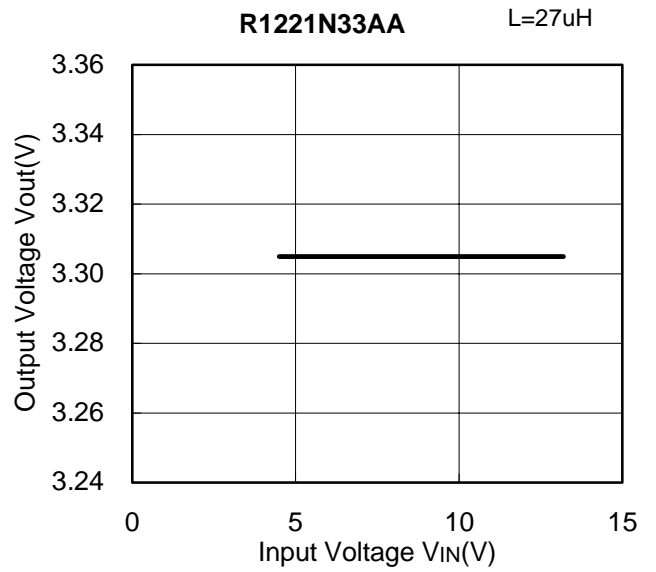
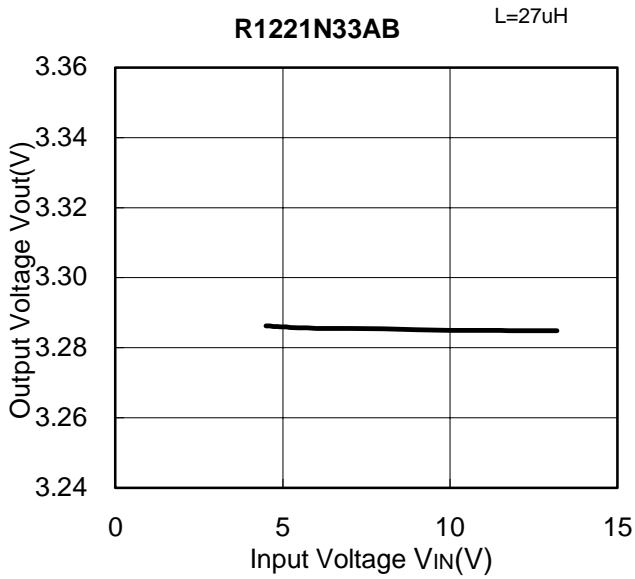

6) Output Voltage vs. Temperature

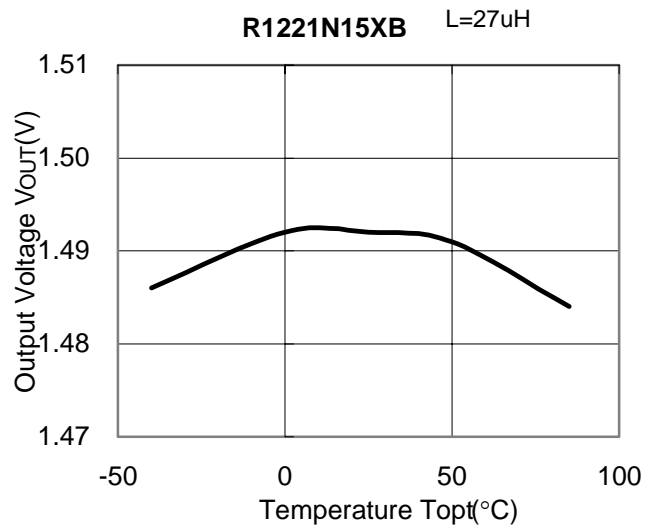
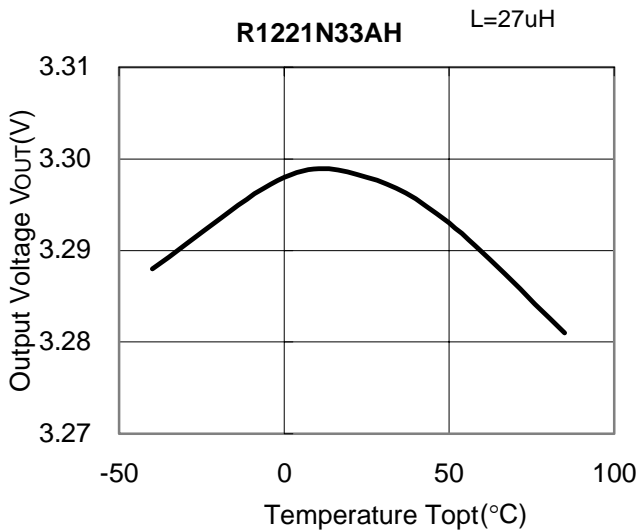

7) Detector Threshold vs. Temperature

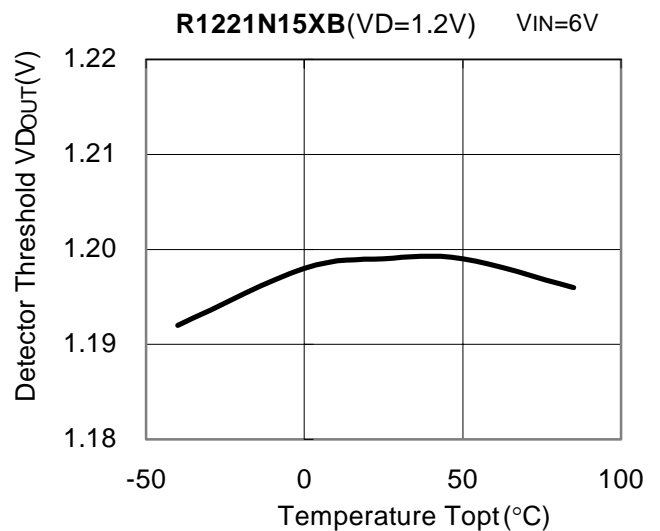
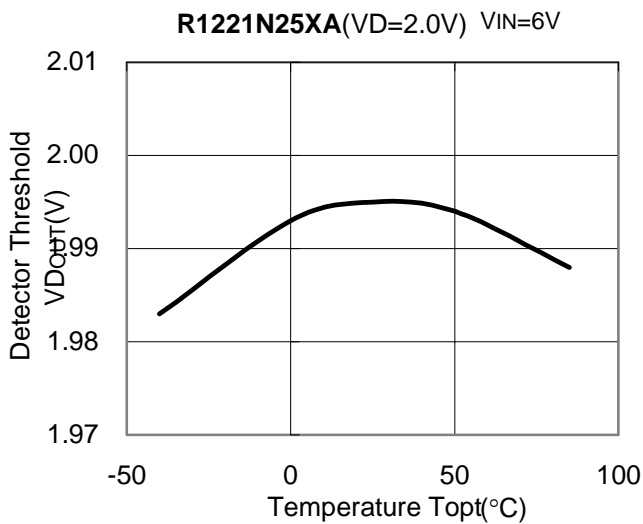

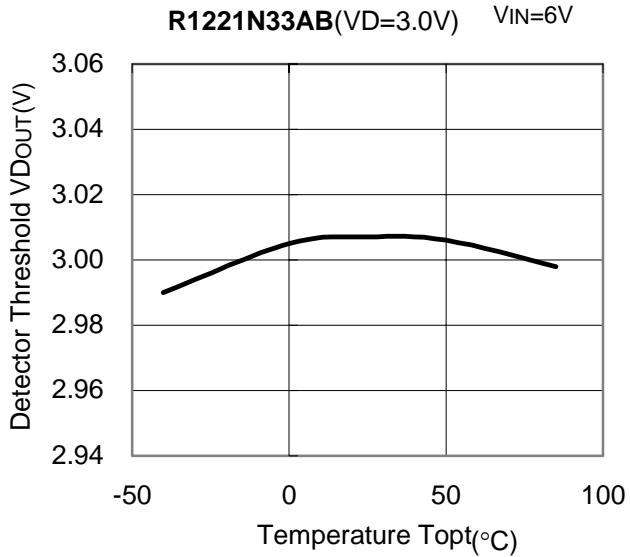

8) Oscillator Frequency vs. Temperature

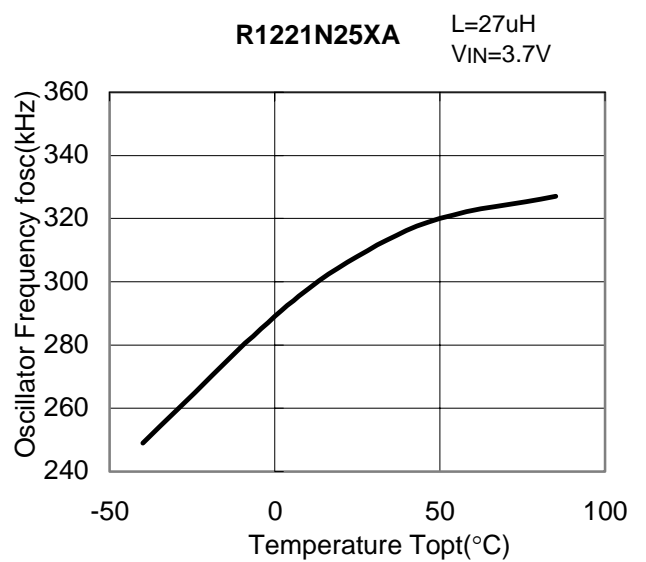
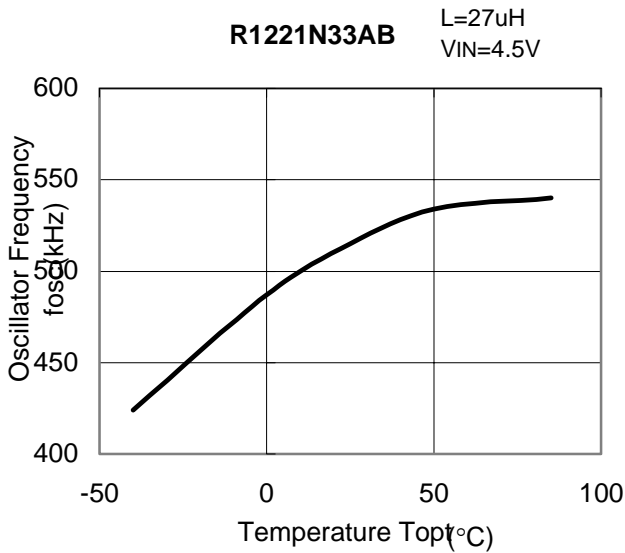

9) Supply Current vs. Temperature

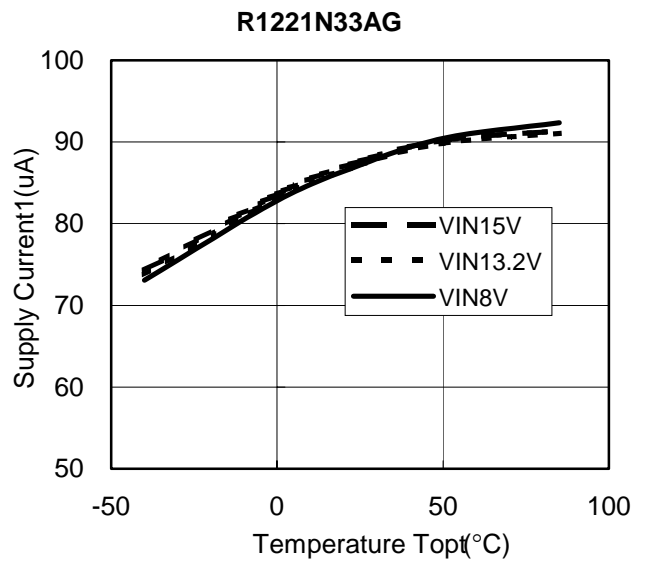
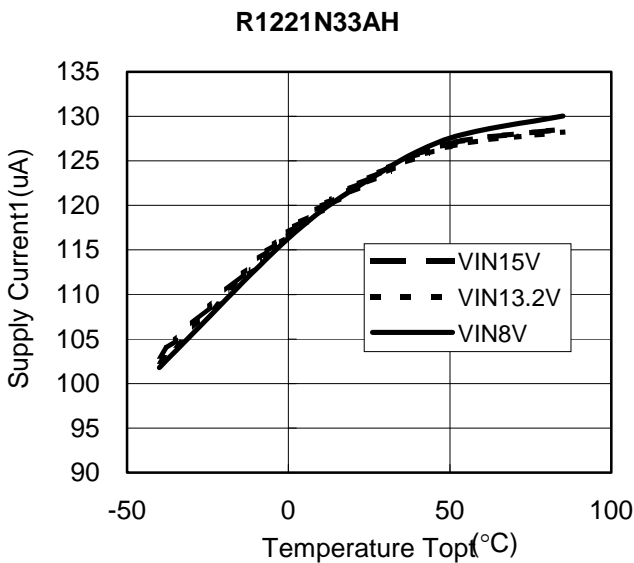

10) Soft-start Time vs. Temperature

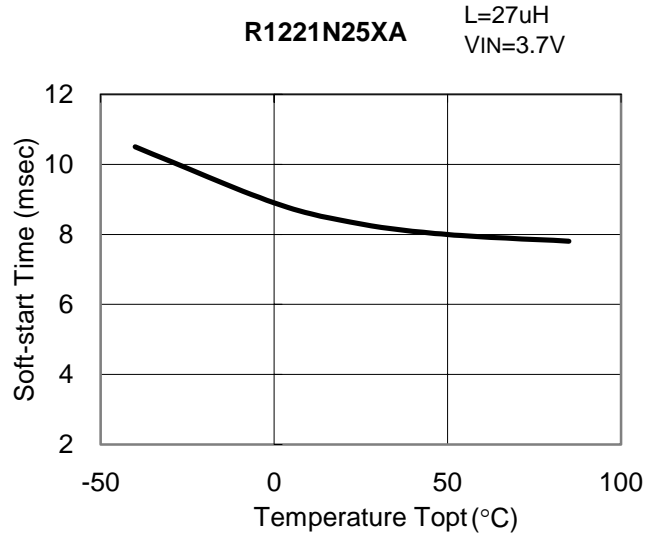
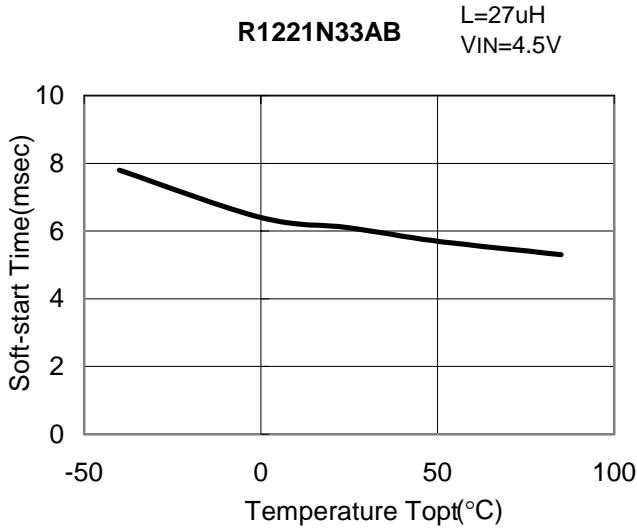

11) Delay Time for Latch-type Protection vs. Temperature

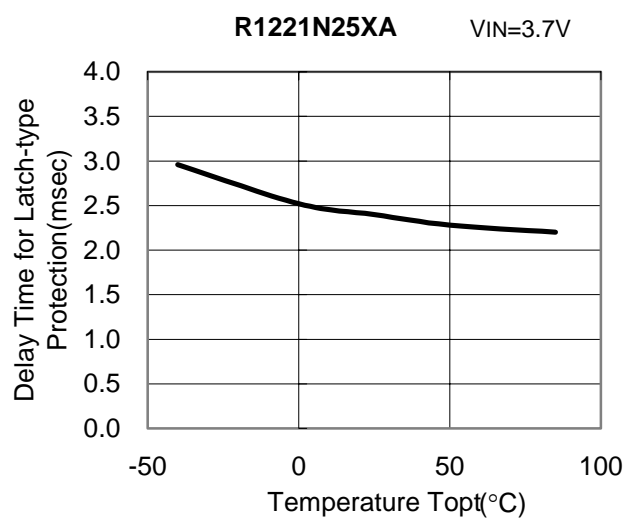
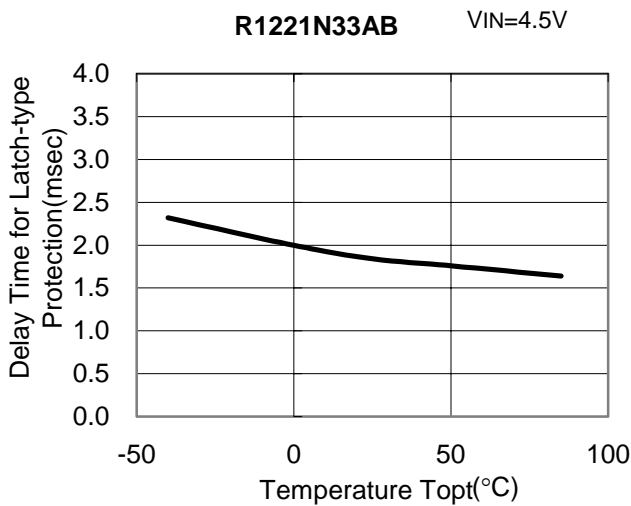

12) Delay Time for Reset-type Protection vs. Temperature

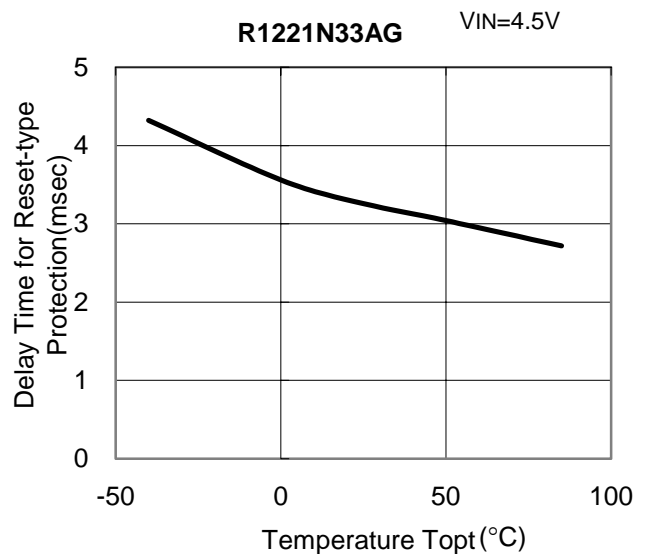
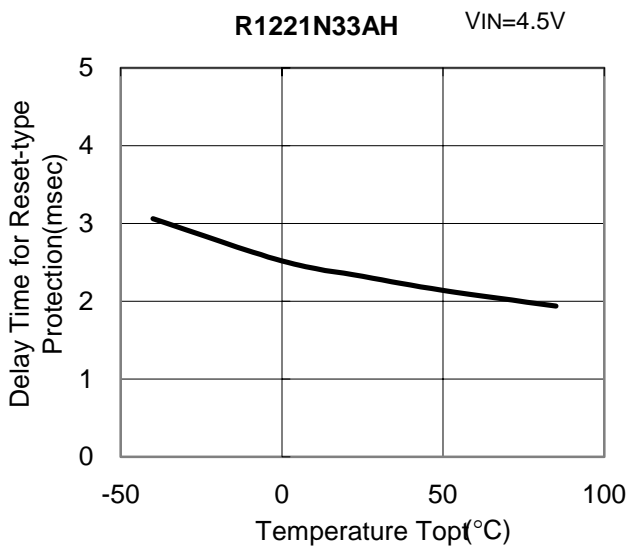

13) VD Output Delay Time vs. Temperature

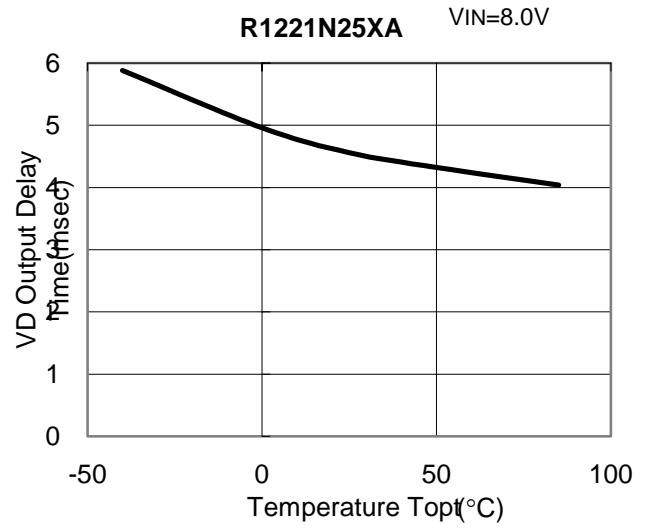
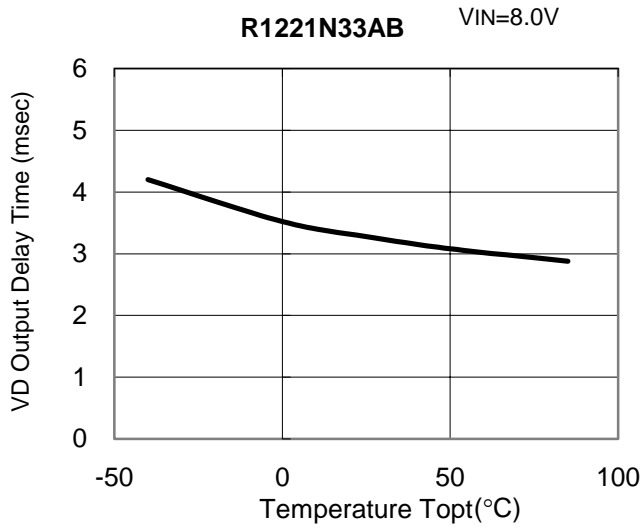

14) EXT "H" Output Current vs. Temperature

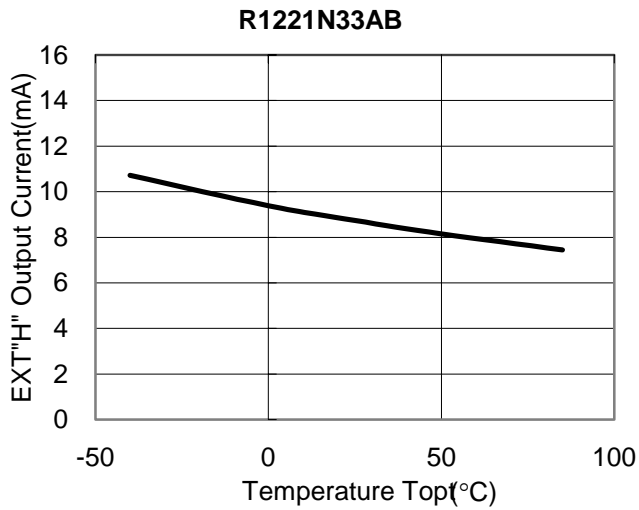

15) EXT "L" Output Current vs. Temperature

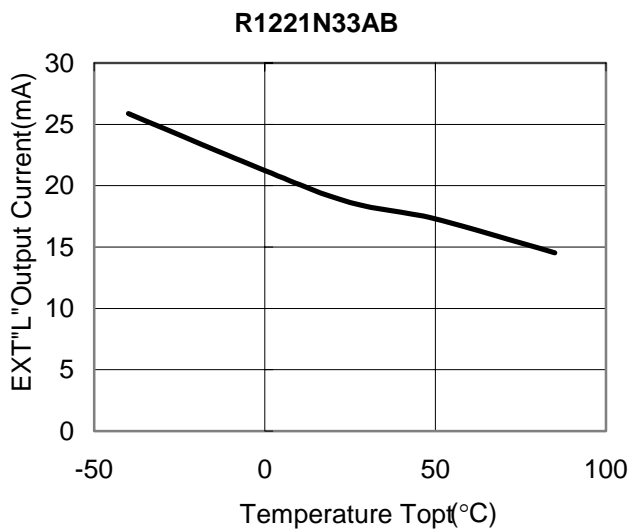

16) VDOUT "L" Output Current vs. Temperature

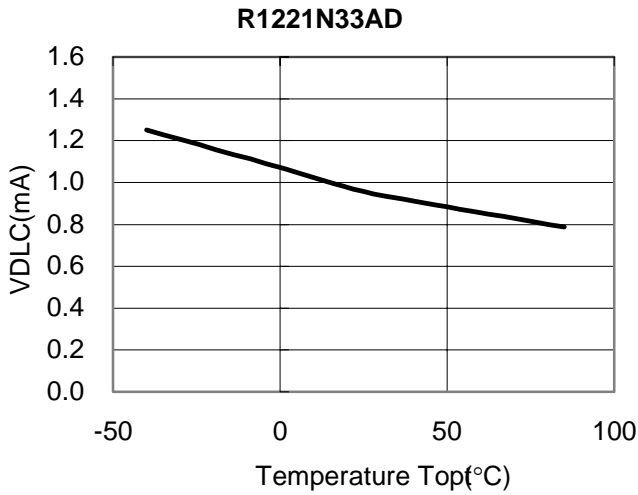

17) Load Transient Response

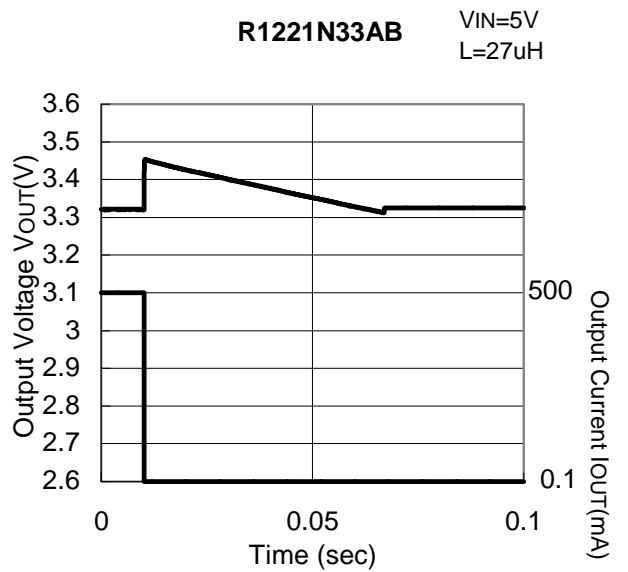
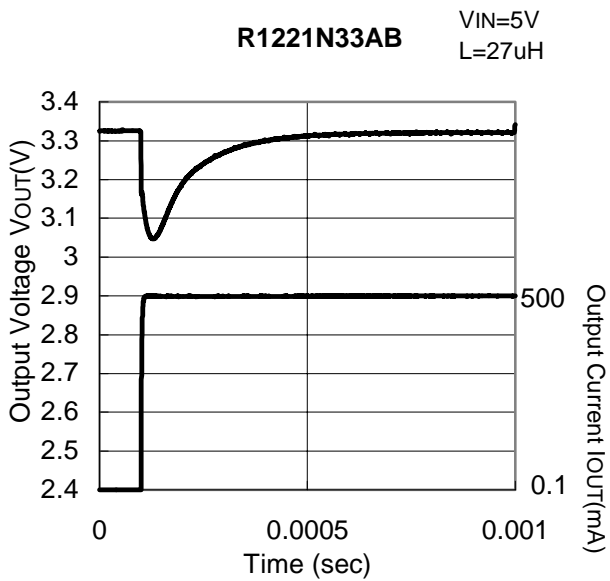
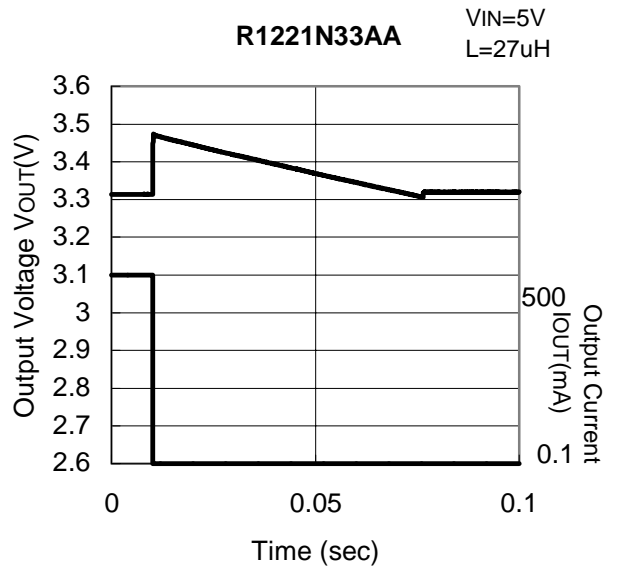
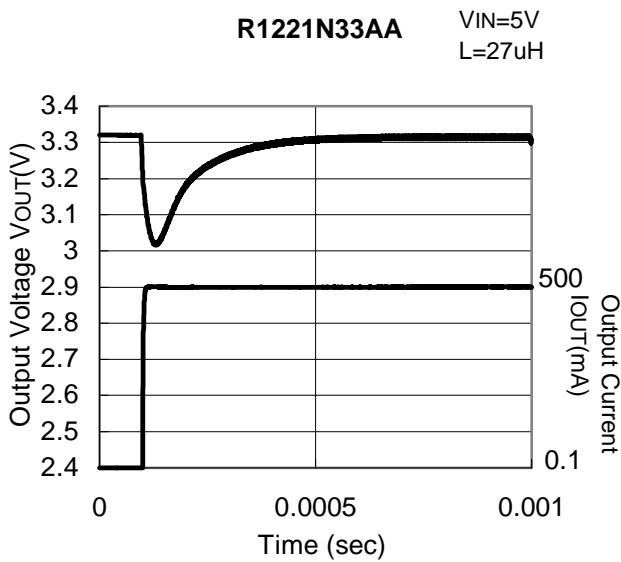

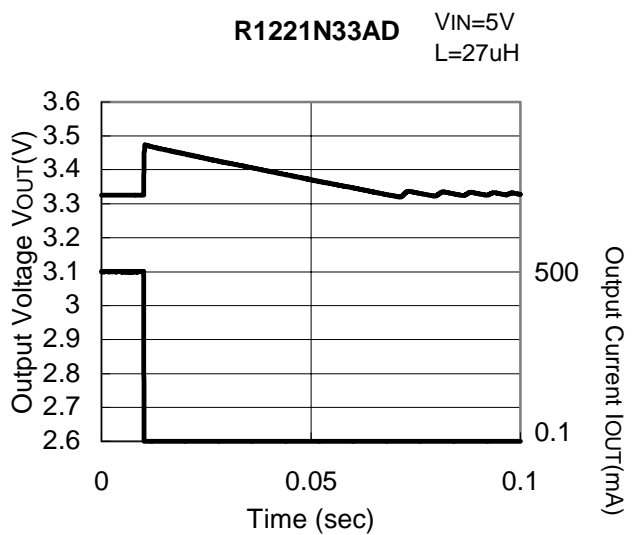
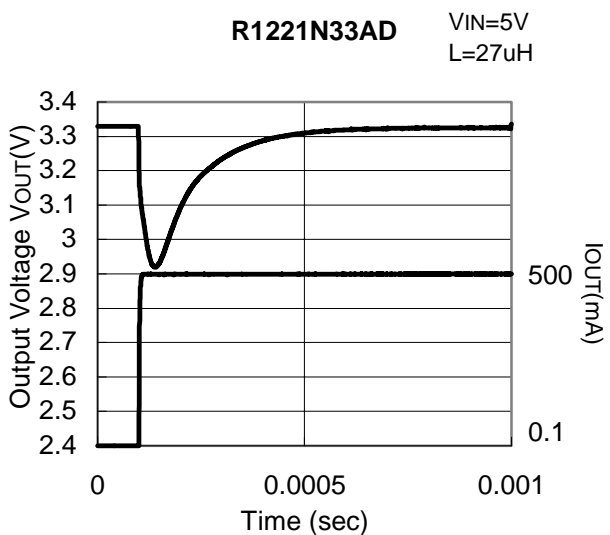
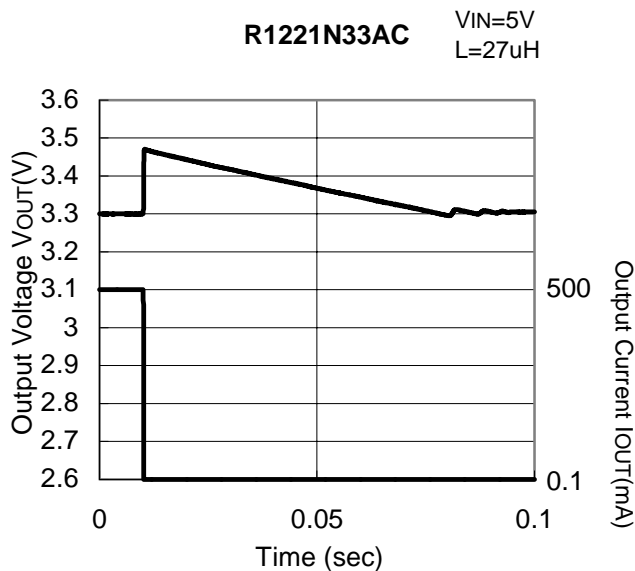
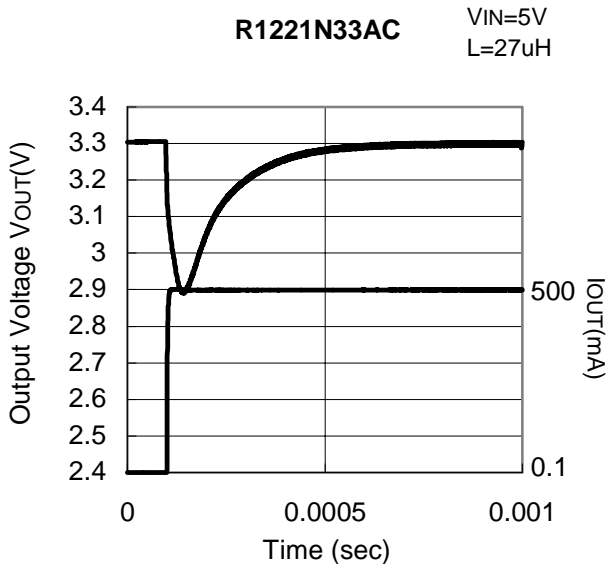

18) Turn-on Waveform

