

Besondere Merkmale

- eingefärbtes, klares Gehäuse
- zur Einkopplung in Lichtleiter
- als optischer Indikator einsetzbar
- Lötspieße ohne Aufsetzebene
- gegurtet lieferbar
- Störimpulsfest nach DIN 40839

Features

- colored, clear package
- optical coupling into light pipes
- for use as optical indicator
- solder leads without stand-off
- available taped on reel
- load dump resistant acc. to DIN 40839

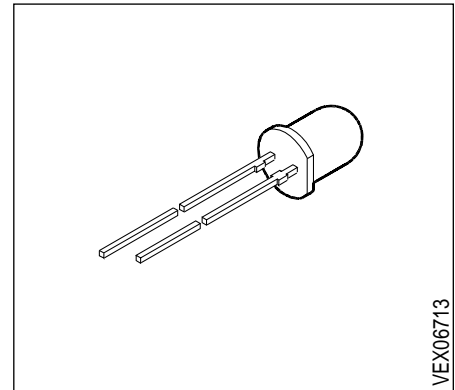

| Typ Type | Emissionsfarbe Color of Emission | Gehäusefarbe Color of Package | Lichtstärke Luminous Intensity $I_F = 10 \text{ mA}$ $I_V \text{ (mcd)}$ | Bestellnummer Ordering Code |
|-------------|--|-------------------------------------|--|--------------------------------|
| LS 5420-MQ | super-red | red clear | 16 ... 125 | Q62703-Q1428 |
| LS 5420-P | | | 40 ... 80 | Q62703-Q1430 |
| LS 5420-Q | | | 63 ... 125 | Q62703-Q1993 |
| LS 5420-R | | | 100 ... 200 | Q62703-Q1429 |
| LS 5420-PT | | | 40 ... 500 | Q62703-Q1431 |
| LY 5420-MQ | yellow | yellow clear | 16 ... 125 | Q62703-Q1432 |
| LY 5420-P | | | 40 ... 80 | Q62703-Q1434 |
| LY 5420-Q | | | 63 ... 125 | Q62703-Q2004 |
| LY 5420-R | | | 100 ... 200 | Q62703-Q3235 |
| LY 5420-PS | | | 40 ... 320 | Q62703-Q1435 |
| LG 5410-MQ | green | colorless clear | 16 ... 125 | Q62703-Q1439 |
| LG 5410-P | | | 40 ... 80 | Q62703-Q1868 |
| LG 5410-Q | | | 63 ... 125 | Q62703-Q2020 |
| LG 5410-R | | | 100 ... 200 | Q62703-Q2021 |
| LG 5410-PS | | | 40 ... 320 | Q62703-Q2022 |

Streuung der Lichtstärke in einer Verpackungseinheit $I_{V \max} / I_{V \min} \leq 2.0$.

Luminous intensity ratio in one packaging unit $I_{V \max} / I_{V \min} \leq 2.0$.

Grenzwerte
Maximum Ratings

| Bezeichnung Parameter | Symbol Symbol | Werte Values | Einheit Unit |
|--|------------------|-----------------|-----------------|
| Betriebstemperatur Operating temperature range | T_{op} | - 55 ... + 100 | °C |
| Lagertemperatur Storage temperature range | T_{stg} | - 55 ... + 100 | °C |
| Sperrschichttemperatur Junction temperature | T_j | + 100 | °C |
| Durchlaßstrom Forward current | I_F | 40 | mA |
| Stoßstrom Surge current $t \leq 10 \mu s, D = 0.005$ | I_{FM} | 0.5 | A |
| Sperrspannung Reverse voltage | V_R | 5 | V |
| Verlustleistung Power dissipation $T_A \leq 25 \text{ °C}$ | P_{tot} | 140 | mW |
| Wärmewiderstand Thermal resistance Sperrschicht / Luft Junction / air | $R_{th JA}$ | 400 | K/W |

Kennwerte ($T_A = 25\text{ °C}$)

Characteristics

| Bezeichnung Parameter | Symbol Symbol | Werte Values | | | Einheit Unit |
|---|-------------------------|-----------------|------------|------------|--------------------------------|
| | | LS | LY | LG | |
| Wellenlänge des emittierten Lichtes (typ.) Wavelength at peak emission (typ.) $I_F = 20\text{ mA}$ | λ_{peak} | 635 | 586 | 565 | nm |
| Dominantwellenlänge (typ.) Dominant wavelength (typ.) $I_F = 20\text{ mA}$ | λ_{dom} | 628 | 590 | 570 | nm |
| Spektrale Bandbreite bei 50 % $I_{\text{rel max}}$ (typ.) Spectral bandwidth at 50 % $I_{\text{rel max}}$ (typ.) $I_F = 20\text{ mA}$ | $\Delta\lambda$ | 45 | 45 | 25 | nm |
| Abstrahlwinkel bei 50 % I_V (Vollwinkel) Viewing angle at 50 % I_V | 2ϕ | 24 | 24 | 24 | Grad deg. |
| Durchlaßspannung (typ.) Forward voltage (max.) $I_F = 10\text{ mA}$ | V_F V_F | 2.0 2.6 | 2.0 2.0 | 2.0 2.6 | V V |
| Sperrstrom (typ.) Reverse current (max.) $V_R = 5\text{ V}$ | I_R I_R | 0.01 10 | 0.01 10 | 0.01 10 | μA μA |
| Kapazität (typ.) Capacitance $V_R = 0\text{ V}, f = 1\text{ MHz}$ | C_0 | 12 | 10 | 15 | pF |
| Schaltzeiten: Switching times: I_V from 10 % to 90 % (typ.) I_V from 90 % to 10 % (typ.) $I_F = 100\text{ mA}, t_p = 10\text{ }\mu\text{s}, R_L = 50\text{ }\Omega$ | t_r t_f | 300 150 | 300 150 | 450 200 | ns ns |

Relative spektrale Emission $I_{rel} = f(\lambda)$, $T_A = 25\text{ °C}$, $I_F = 20\text{ mA}$

Relative spectral emission

$V(\lambda)$ = spektrale Augenempfindlichkeit

Standard eye response curve

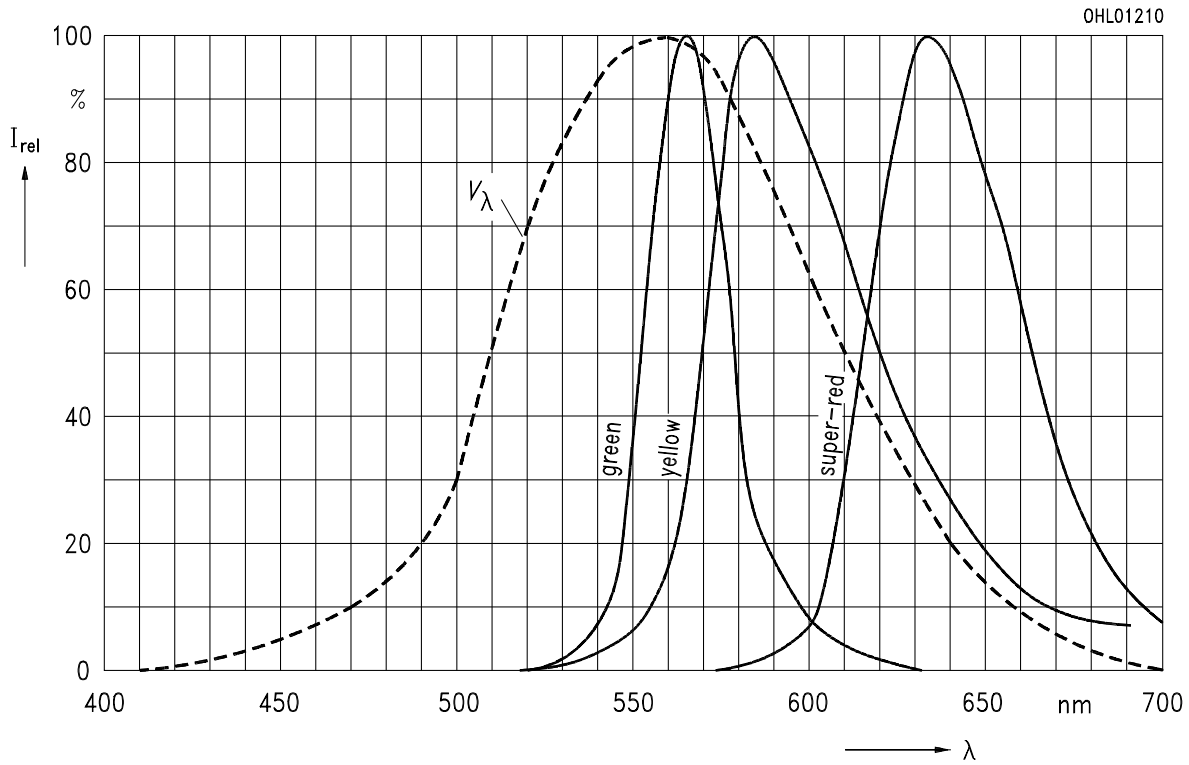

Abstrahlcharakteristik $I_{rel} = f(\varphi)$

Radiation characteristic

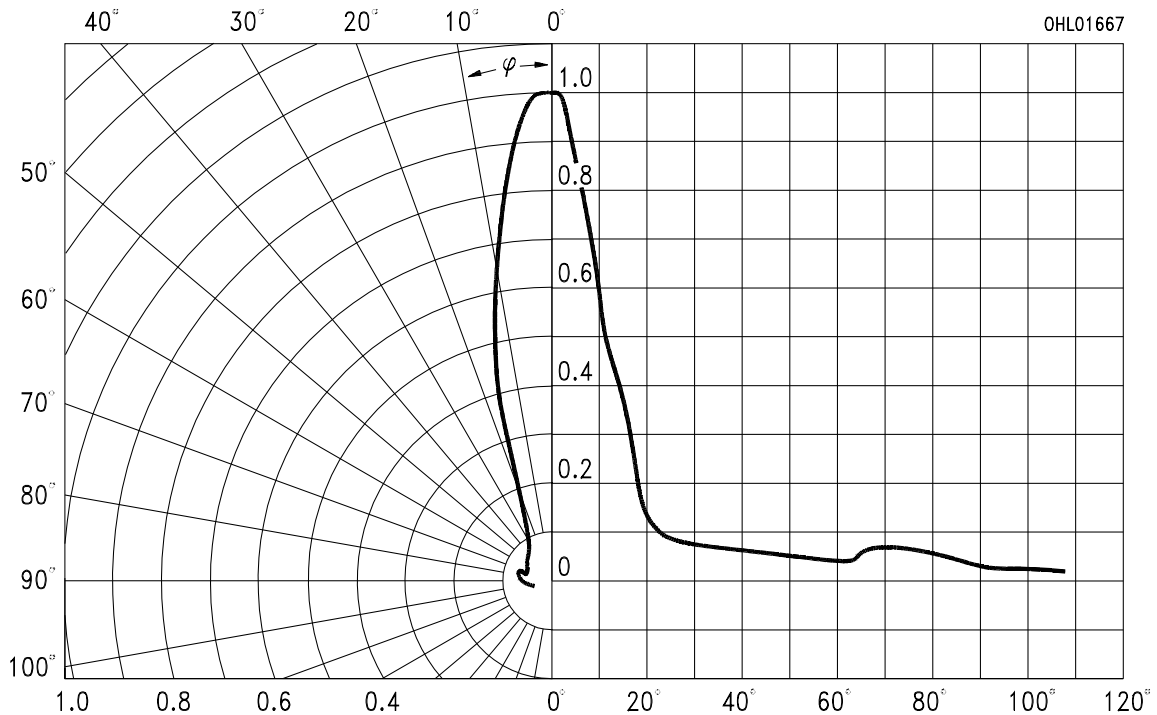

Durchlaßstrom $I_F = f(V_F)$

Forward current

$T_A = 25\text{ °C}$

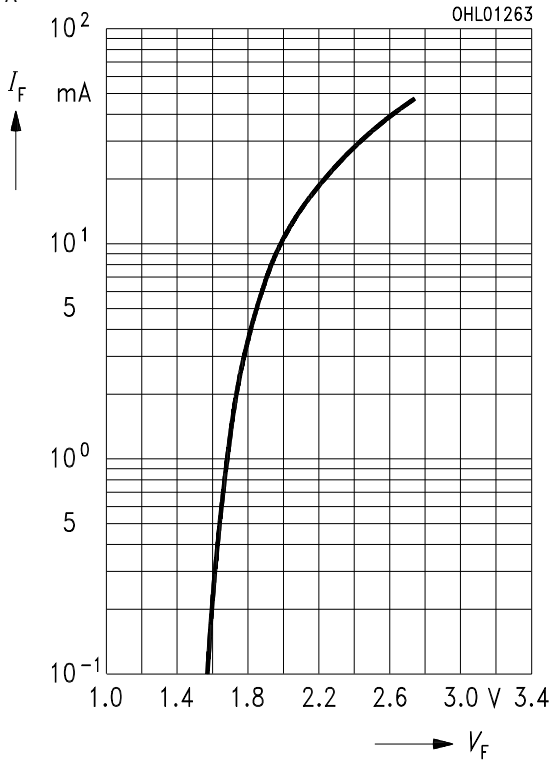

Relative Lichtstärke $I_V/I_{V(10\text{ mA})} = f(I_F)$

Relative luminous intensity

$T_A = 25\text{ °C}$

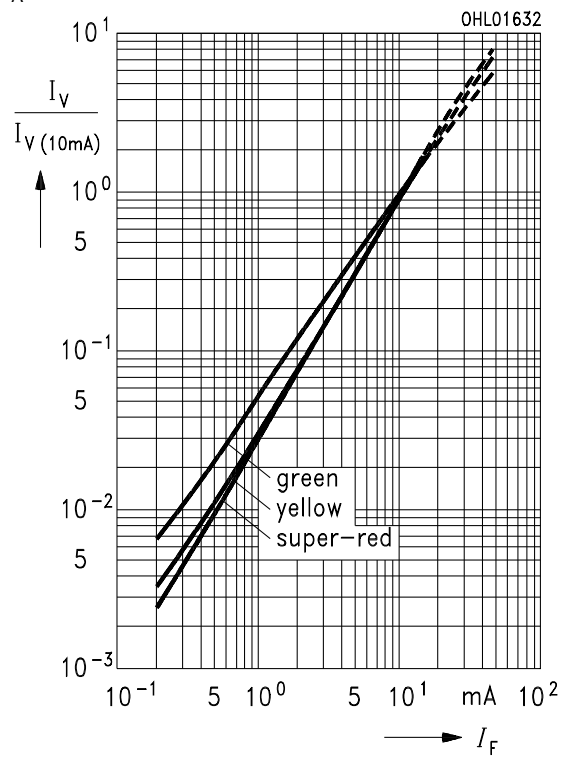

Zulässige Impulsbelastbarkeit $I_F = f(t_p)$

Permissible pulse handling capability

Duty cycle $D =$ parameter, $T_A = 25\text{ °C}$

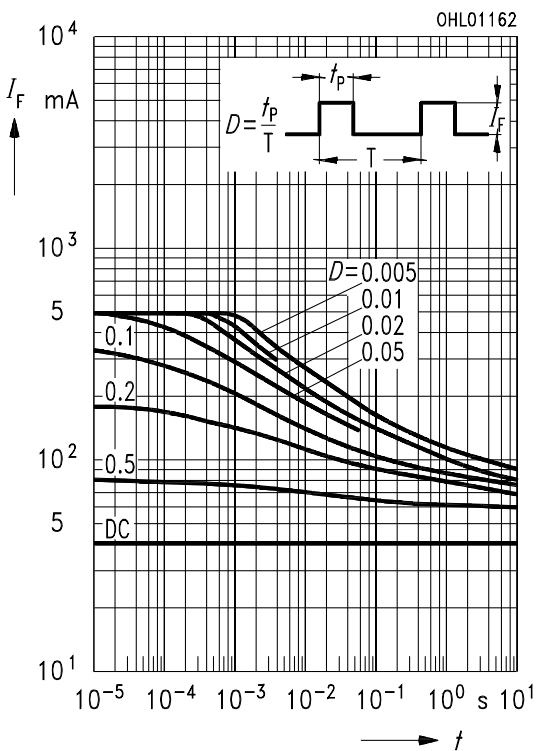

Maximal zulässiger Durchlaßstrom

Max. permissible forward current

$I_F = f(T_A)$

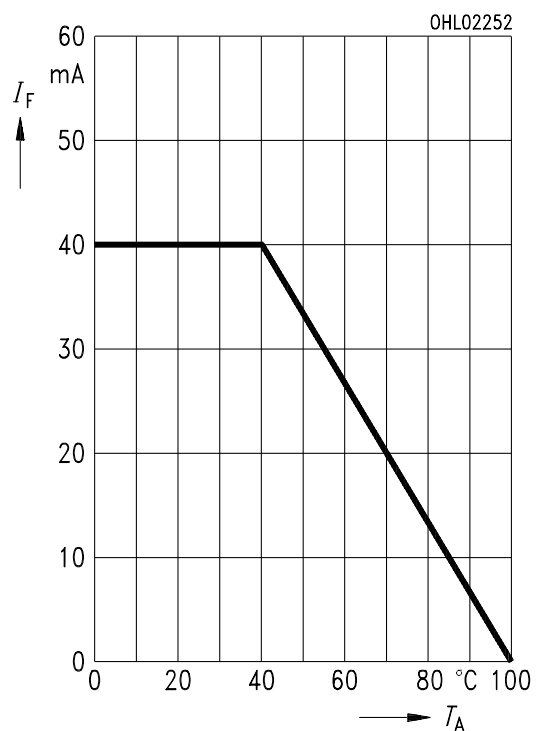

Wellenlänge der Strahlung $\lambda_{\text{peak}} = f(T_A)$
Wavelength at peak emission

$I_F = 20 \text{ mA}$

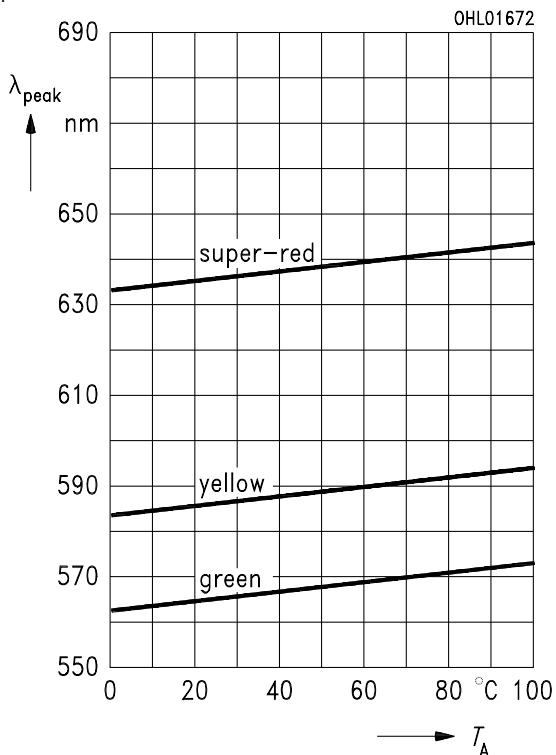

Dominantwellenlänge $\lambda_{\text{dom}} = f(T_A)$
Dominant wavelength

$I_F = 20 \text{ mA}$

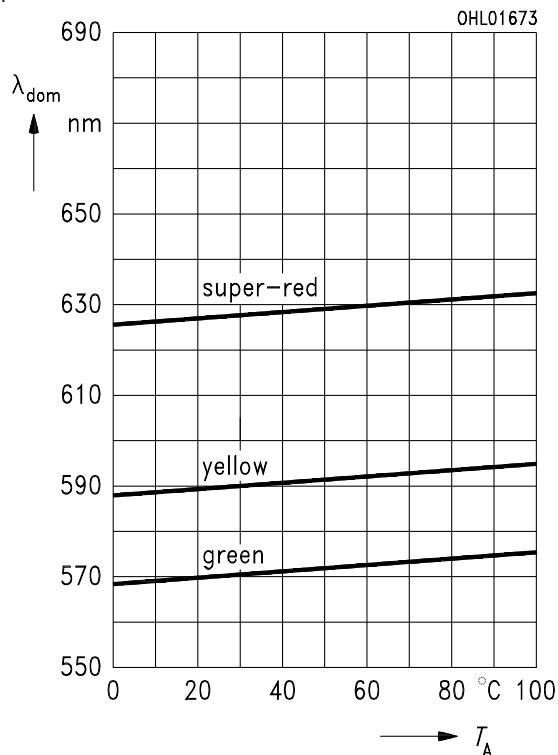

Durchlaßspannung $V_F = f(T_A)$
Forward voltage

$I_F = 10 \text{ mA}$

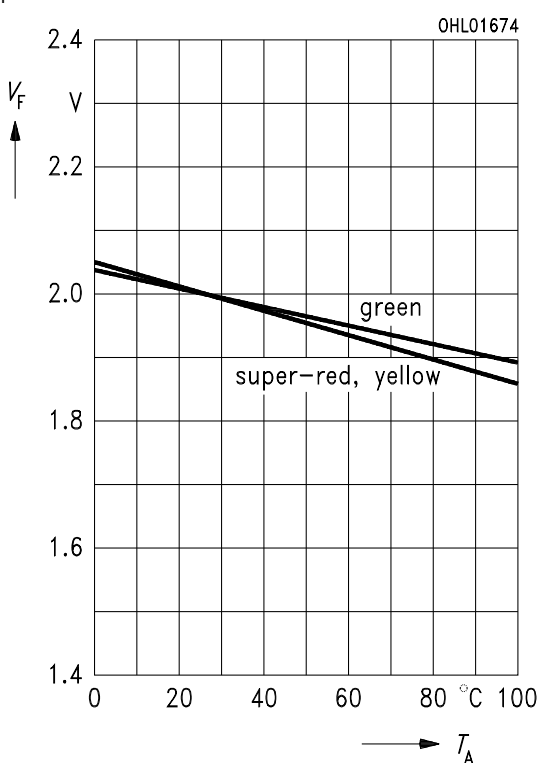

Relative Lichtstärke $I_V/I_{V(25^\circ\text{C})} = f(T_A)$
Relative luminous intensity

$I_F = 10 \text{ mA}$

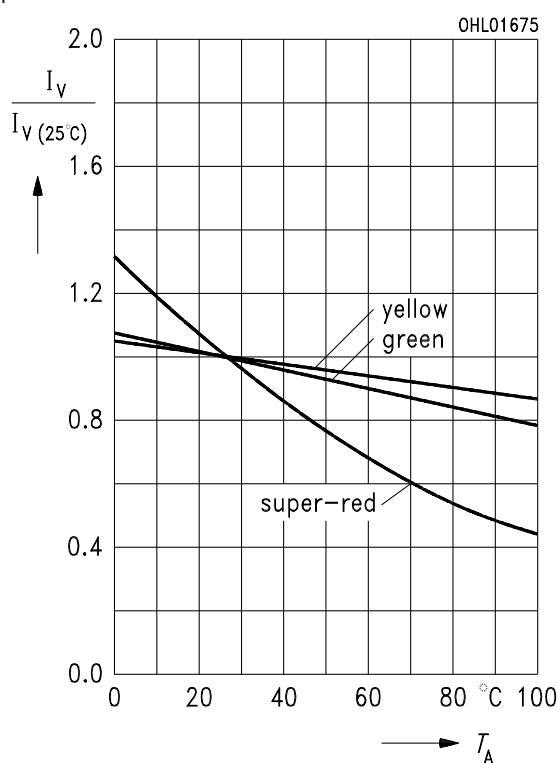

Maßzeichnung (Maße in mm, wenn nicht anders angegeben)

Package Outlines (Dimensions in mm, unless otherwise specified)

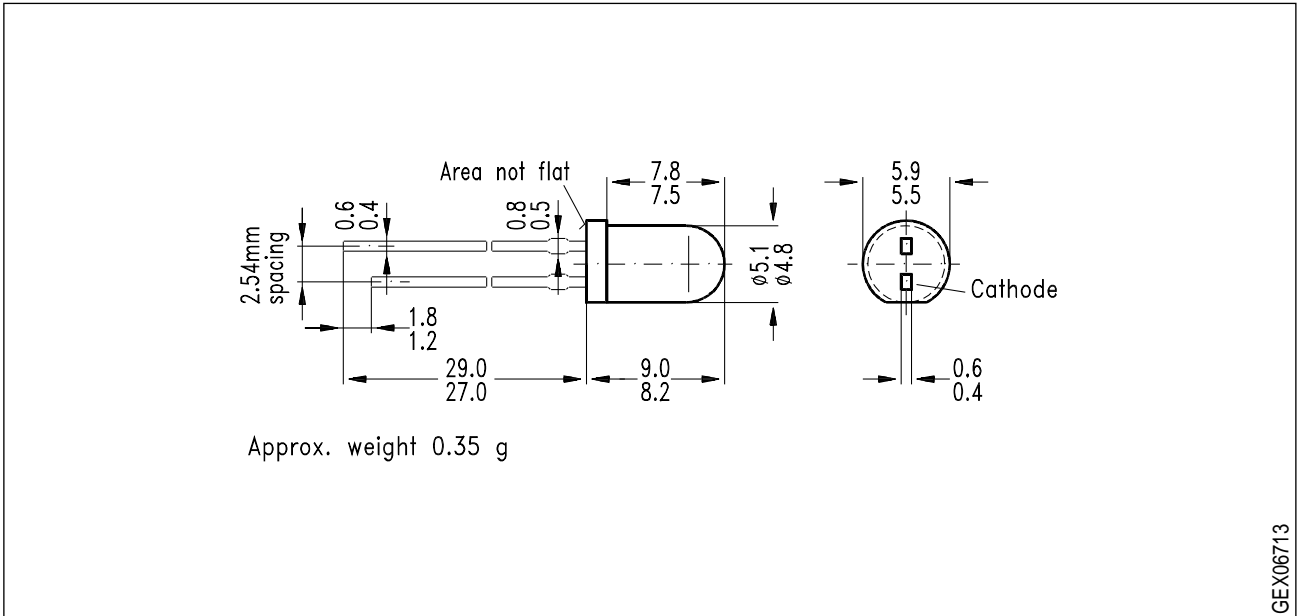

Kathodenkennzeichnung: Kürzerer Lötspieß

Cathode mark: Short solder lead