

VC-700 Voltage Controlled Crystal Oscillator

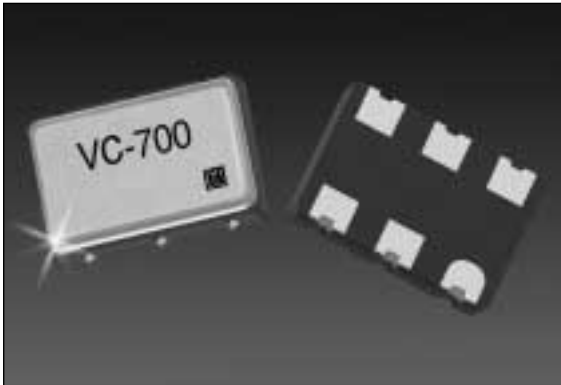

Features

- Small Industry Standard Package, 5.0 x 7.5 x 2.8 mm
- Output Frequencies from 77.76 MHz to 180 MHz
- 3.3 V or 5 V Operation
- HFF crystal for ultra low jitter
- Complementary PECL Outputs
- Low phase noise and custom options
- 0/70 °C or -40/85 °C operating temperature
- Enable /Disable (PECL)

Applications

PLL circuits for Clock Smoothing and Frequency Translation

- Fiber Channel
- SONET
- SDH, ITU-T G.709
- SONET, GR-253-CORE Issue3

Description

The VC-700 is a voltage controlled crystal oscillator that operates at the fundamental frequency of the internal HFF crystal. The HFF crystal is a high-Q quartz device that enables the circuit to achieve low phase jitter performance over a wide operating temperature range. The oscillator is housed in an industry standard hermetically sealed leadless surface mount package and is available on tape and reel.

VC-700 Voltage Controlled Crystal Oscillator

Electrical Performance

Parameter	Symbol	Minimum	Typical	Maximum	Units	Notes
Frequency	f_o	77.76		180	MHz	
Supply Voltage	(+3.3V)	V_{DD}	3.15	3.3	3.45	V
	(+5.0V)	V_{DD}	4.75	5.0	5.25	V
Supply Current	I_{DD}			<65	mA	
Output Logic Levels						
Output Logic High	0/70 °C	V_{OH}	$V_{CC} - 1.025$		$V_{CC} - 0.880$	V
Output Logic low	0/70 °C	V_{OL}	$V_{CC} - 1.810$		$V_{CC} - 1.620$	V
Output Logic High	-40/85 °C	V_{OH}	$V_{CC} - 1.085$		$V_{CC} - 1.880$	V
Output Logic low	-40/85 °C	V_{OL}	$V_{CC} - 1.830$		$V_{CC} - 1.555$	V
Transition Times						
Rise Time	t_r			1	ns	
Fall Time	t_f			1	ns	
Symmetry or Duty Cycle	SYM	45	50	55	%	
Operating Temperature <small>ordering option</small>		0/70 or -40/85			°C	
Jitter (12 kHz – 20 MHz BW)			0.3		ps (RMS)	
Jitter (50 kHz – 80 MHz BW)			0.5		ps (RMS)	
Test Conditions for APR (+5V option)	V_c	0.5		4.5	V	
Test Conditions for APR (+3.3V option)	V_c	0.3		3.0	V	
Absolute Pull Range (APR)	APR	± 32 ± 50			ppm	
Gain Transfer			Positive			
Control Voltage Bandwidth (-3dB)	BW	10			kHz	
Package Size		5.0 x 7.5 x 2.8				

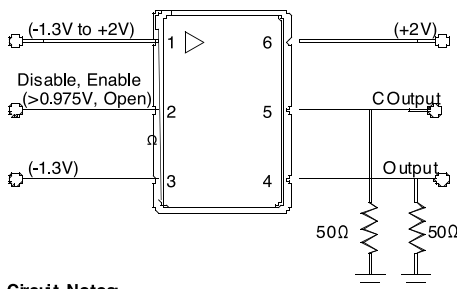

Test Circuit Notes:

- 1) To Permit 50Ω Measurement of Outputs, all DC Inputs are Biased Down 1.3V
- 2) All Voltage Sources Contain Bypass Capacitors to Minimize Supply Noise
- 3) 50Ω Terminations are Within Test Equipment.

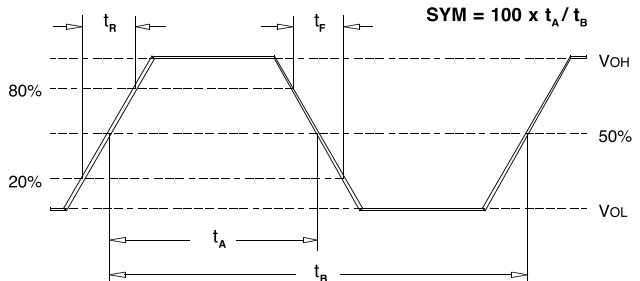

VC-700 Voltage Controlled Crystal Oscillator

Outline Diagram

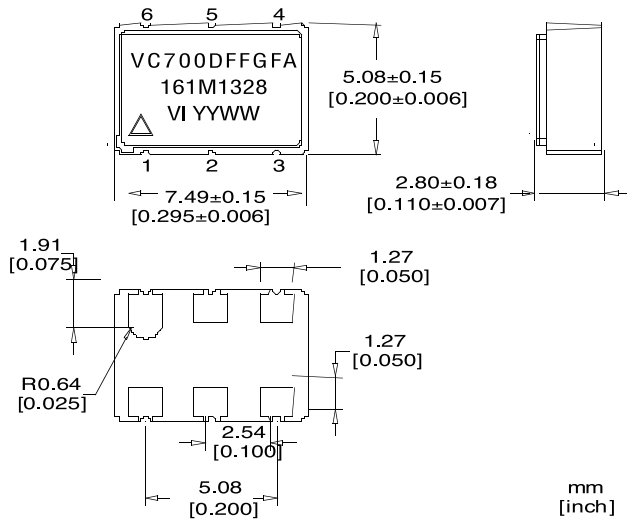

Pad Layout

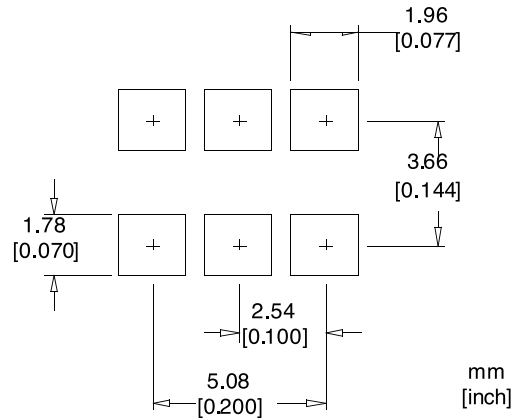

Pin Out

Pin	Symbol	Function
1	Vc	VCXO Control Voltage
2	N/C or OE	Output Disable Enabled = PECL Logic 0 (or Open) Disabled = PECL Logic 1
3	GND	Case and Electrical Ground
4	Output	Output
5	COutput	Complementary Output
6	Vcc	Power Supply Voltage (3.3V or 5V)

Tape and Reel (EIA-481-2-A)

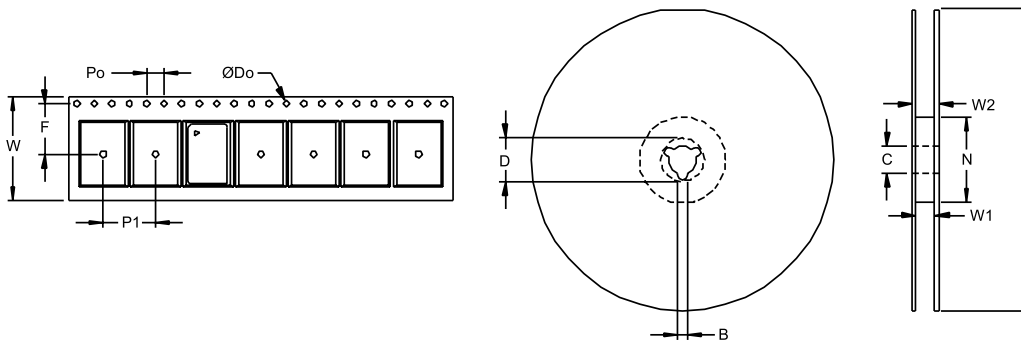

Tape Dimensions (mm)

Reel Dimension (mm)

Dimension	W	F	Do	Po	P1	A	B	C	D	N	W1	W2	# Per Reel
Tolerance	Typ	Typ	Typ	Typ	Typ	Typ	Min	Typ	Min	Min	Typ	Max	
VC-700	16	7.5	1.5	4	8	178	1.5	13	20.2	50	16.4	22.4	200

VC-700 Voltage Controlled Crystal Oscillator

Absolute Maximum Ratings

Parameter	Symbol	Ratings	Unit
Power Supply	Vcc	0 to 6	V
Output Current	Iout	25	mA
Voltage Control Range	Vc	0 to Vcc	V
Storage Temperature	TS	-55 to 125	°C
Soldering Temp/Time	TLs	220/10	°C/sec

Stresses in excess of the absolute maximum ratings can permanently damage the device. Functional operation is not implied at these or any other conditions in excess of conditions represented in the operational sections of this data sheet. Exposure to absolute maximum ratings for extended periods may adversely affect device reliability.

Reliability

The VC-700 family is capable of meeting the following qualification tests:

Environmental Compliance

Parameter	Conditions
Mechanical Shock	MIL-STD-883, Method 2002
Mechanical Vibration	MIL-STD-883, Method 2007
Solderability	MIL-STD-883, Method 2003
Gross and Fine Leak	MIL-STD-883, Method 1014
Resistance to Solvents	MIL-STD-883, Method 2015

Handling Precautions

Although ESD protection circuitry has been designed into the VC-700 proper precautions should be taken when handling and mounting. VI employs a human body model and a charged-device model (CDM) for ESD susceptibility testing and design protection evaluation.

ESD Ratings

Model	Minimum	Conditions
Human Body Model	500	MIL-STD 883, Method 3015
Charged Device Model	500	JESD 22-C101

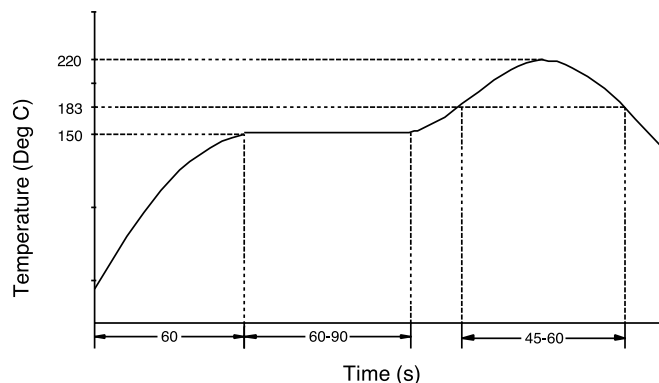

VI qualification includes aging at various extreme temperatures, shock and vibration, temperature cycling, and IR reflow simulation. The conditions a device can withstand are well understood and devices can be subjected to the profile above. This profile shows a ramp up condition to prevent thermal shock, a preheat period in which the flux is activated, a ramp up to 183°C which is the reflow temperature of Sn/Pb eutectic, and a gradual cool down. The time above 183°C should not exceed 60 seconds and the peak temperature should be no more than 220°C for 10 seconds. The VC-700's are hermetically sealed so an aqueous wash is not an issue.

VC-700 Voltage Controlled Crystal Oscillator

Standard Frequencies (MHz)

155.520	156.250	161.1328	167.3316				

Other frequencies available upon request

Ordering Information

VC-700 - D F F - G F A - xxx.xxx

Product Family

VC: VCXO

Package

700: 5.0 x 7.5 x 2.8 mm

Input

C: 5.0Vdc ± 5%
D: 3.3 Vdc ± 5%

Output

F: Complementary
PECL

Operating Temperature

C: 0 to 70°C
F: -40 to 85°C

Frequency (See Above)

77.6 - 180 MHz

Linearity, Stability

A: N/A
L: ± 10 linearity
M: ± 20 ppm stability

Enable - Disable

A: N/A
F: Pin 2

Absolute Pull Range *

F: ± 32 ppm
G: ± 50 ppm

* Consult factory for other possible APR levels.

VC-700 Voltage Controlled Crystal Oscillator

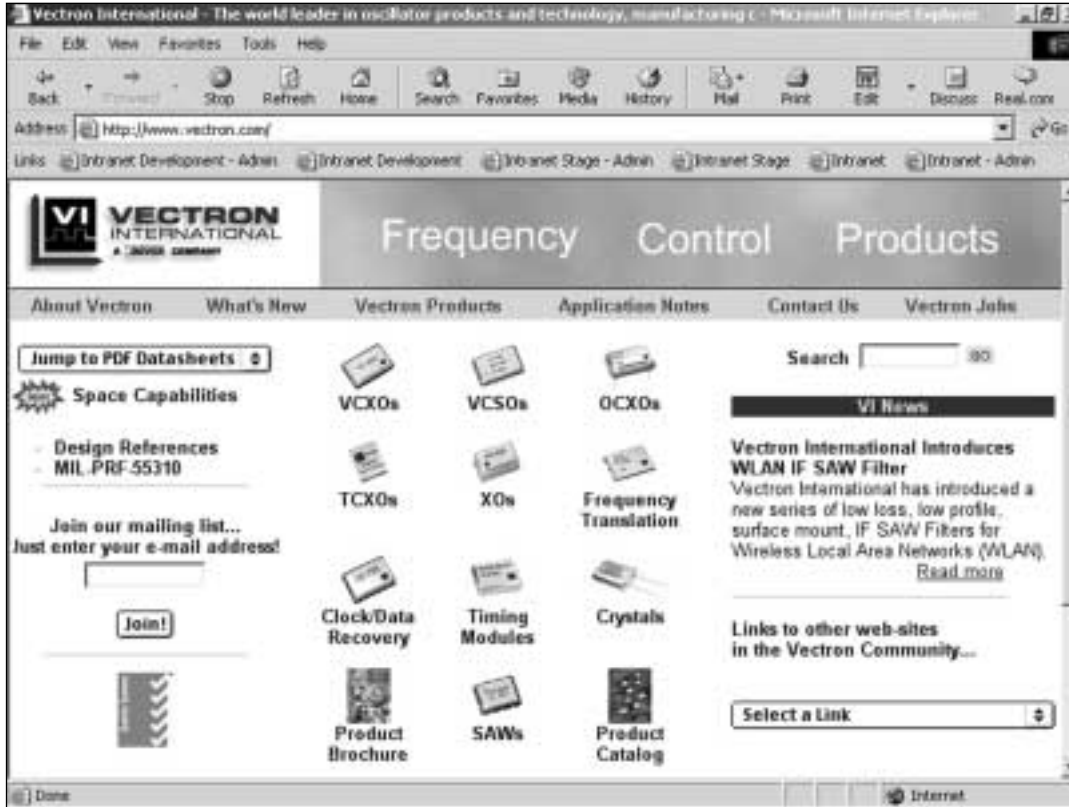

VISIT US AT
www.vectron.com

For additional information please contact:



USA: Vectron International • 267 Lowell Road, Hudson, NH 03051 Tel: 1-888-VECTRON-1 • Fax: 1-888-FAX-VECTRON
EUROPE: Tel: +49 (0) 3328 4784 17 • +49 (0) 3328 4784 30
ASIA: Tel: 0086 21 28909740 • Fax: 0086 21 28909240

www.vectron.com

Vectron International reserves the right to make changes to the product(s) and/or information contained herein without notice. No liability is assumed as a result of their use or application. No rights under any patent accompany the sale of any such product(s) or information.

©2002, Vectron International.

Rev.02 January 03